

**SAMSUNG**

**GT-I8530**  
user manual



# Using this manual

Thank you for purchasing this Samsung mobile device. This device will provide you with high quality mobile communication and entertainment based on Samsung's exceptional technology and high standards.

This user manual has been specially designed to guide you through the functions and features of your device.

## Read me first

- Please read all safety precautions and this manual carefully before using your device to ensure safe and proper use.
- The descriptions in this manual are based on the default settings of your device.
- Images and screenshots used in this user manual may differ in appearance from the actual product.
- Content in this user manual may differ from the product, or from software provided by service providers or carriers, and is subject to change without prior notice. Refer to [www.samsung.com](http://www.samsung.com) for the latest version of the user manual.
- Available features and additional services may vary by device, software, or service provider.
- Formatting and delivery of this user manual is based on Google Android operating systems and may vary depending on the user's operating system.
- Applications and their functions may vary by country, region, or hardware specifications. Samsung is not liable for performance issues caused by third-party applications.
- Samsung is not liable for performance issues or incompatibilities caused by edited registry settings or modified operating system software. Attempting to customise the operating system may cause your device or applications to work improperly.

- You may upgrade your mobile device's software by accessing [www.samsung.com](http://www.samsung.com).
- Software, sound sources, wallpapers, images, and other contents provided in this device are licenced for limited use between Samsung and their respective owners. Extracting and using these materials for commercial or other purposes is an infringement of copyright laws. Samsung is not liable for such copyright infringement by the user.
- Please keep this manual for future reference.

## Instructional icons

Before you start, familiarise yourself with the icons you will see in this manual:



**Warning**—situations that could cause injury to yourself or others



**Caution**—situations that could cause damage to your device or other equipment



**Note**—notes, usage tips, or additional information



**Refer to**—pages with related information; for example: ► p. 12 (represents “see page 12”)



**Followed by**—the order of options or menus you must select to perform a step; for example: In Idle mode, open the application list and select **Settings** → **About phone** (represents **Settings**, followed by **About phone**)



**Square brackets**—device keys; for example: [≡] (represents the Menu key)

# Copyright

Copyright © 2012 Samsung Electronics

This user manual is protected under international copyright laws.

No part of this user manual may be reproduced, distributed, translated, or transmitted in any form or by any means, electronic or mechanical, including photocopying, recording, or storing in any information storage and retrieval system, without the prior written permission of Samsung Electronics.

# Trademarks

- SAMSUNG and the SAMSUNG logo are registered trademarks of Samsung Electronics.
- The Android logo, Google™, Google Maps™, Google Mail™, YouTube™, Google Play™ Store, and Google Talk™ are trademarks of Google, Inc.
- Bluetooth® is a registered trademark of the Bluetooth SIG, Inc. worldwide.
- Wi-Fi®, Wi-Fi Protected Setup™, Wi-Fi Direct™, Wi-Fi CERTIFIED™, and the Wi-Fi logo are registered trademarks of the Wi-Fi Alliance.
- DivX®, DivX Certified® and associated logos are trademarks of Rovi Corporation or its subsidiaries and are used under licence.



- All other trademarks and copyrights are the property of their respective owners.



**CE 0168**

### **ABOUT DIVX VIDEO**

DivX<sup>®</sup> is a digital video format created by DivX, LLC, a subsidiary of Rovi Corporation. This is an official DivX Certified<sup>®</sup> device that plays DivX video. Visit [www.divx.com](http://www.divx.com) for more information and software tools to convert your files into DivX videos.

### **ABOUT DIVX VIDEO-ON-DEMAND**

This DivX Certified<sup>®</sup> device must be registered in order to play purchased DivX Video-on-Demand (VOD) movies. To obtain your registration code, locate the DivX VOD section in your device setup menu. Go to [vod.divx.com](http://vod.divx.com) for more information on how to complete your registration.

DivX Certified<sup>®</sup> to play DivX<sup>®</sup> video up to HD 720p, including premium content.

# Contents

|   |           |
|---|-----------|
| <b>Assembling</b> .....                               | <b>10</b> |
| Unpack .....  | 10        |
| Install the SIM or USIM card .....                    | 11        |
| Install the battery .....                             | 12        |
| Charge the battery .....                              | 13        |
| Insert a memory card (optional) .....                 | 16        |
| <b>Getting started</b> .....                          | <b>19</b> |
| Turn your device on and off .....                     | 19        |
| Get to know your device .....                         | 20        |
| Use the touch screen .....                            | 26        |
| Lock or unlock the touch screen and keys .....        | 27        |
| Get to know the idle screen .....                     | 27        |
| Access applications .....                             | 30        |
| Customise your device .....                           | 33        |
| Enter text .....                                      | 37        |
| Download applications from Play Shop (Play Store) ... | 41        |
| Download files from the web .....                     | 42        |
| Synchronise data .....                                | 43        |
| <b>Communication</b> .....                            | <b>45</b> |
| Calling .....   | 45        |
| Messaging .....                                       | 52        |
| Google Mail .....                                     | 54        |
| Email .....   | 56        |
| Talk .....  | 58        |
| ChatON .....  | 59        |
| Messenger .....                                       | 60        |

|                                   |           |
|-----------------------------------|-----------|
| Google+ .....                     | 60        |
| Social Hub .....                  | 61        |
| <b>Entertainment .....</b>        | <b>62</b> |
| Camera .....                      | 62        |
| Video player .....                | 72        |
| Gallery .....                     | 73        |
| Photo editor .....                | 76        |
| Music player .....                | 77        |
| Music Hub .....                   | 80        |
| FM radio .....                    | 80        |
| Game Hub .....                    | 83        |
| <b>Personal information .....</b> | <b>84</b> |
| Contacts .....                    | 84        |
| Calendar .....                    | 88        |
| Task .....                        | 90        |
| Memo .....                        | 90        |
| Voice recorder .....              | 92        |
| <b>Web .....</b>                  | <b>93</b> |
| Internet .....                    | 93        |
| Maps .....                        | 97        |
| Latitude .....                    | 98        |
| Places .....                      | 99        |
| Navigation .....                  | 100       |
| YouTube .....                     | 101       |
| Samsung Apps .....                | 102       |
| Play Shop (Play Store) .....      | 103       |
| News & Weather .....              | 103       |

|                                |            |
|--------------------------------|------------|
| <b>Connectivity</b> .....      | <b>105</b> |
| Bluetooth .....                | 105        |
| Wi-Fi .....                    | 107        |
| Wi-Fi Direct .....             | 109        |
| AllShare .....                 | 110        |
| Mobile network sharing .....   | 113        |
| GPS .....                      | 114        |
| PC connections .....           | 115        |
| VPN connections .....          | 117        |
| <br>                           |            |
| <b>Tools</b> .....             | <b>120</b> |
| Clock .....                    | 120        |
| Calculator .....               | 122        |
| Downloads .....                | 123        |
| Mini diary .....               | 124        |
| My files .....                 | 125        |
| Polaris Office .....           | 125        |
| Projector .....                | 127        |
| Search .....                   | 131        |
| SIM Toolkit .....              | 131        |
| Task manager .....             | 132        |
| Voice command .....            | 132        |
| Voice Search .....             | 133        |
| Voice talk .....               | 133        |
| <br>                           |            |
| <b>Settings</b> .....          | <b>134</b> |
| Access the Settings menu ..... | 134        |
| Wireless and network .....     | 134        |
| Call .....                     | 136        |
| Sound .....                    | 138        |



|                                 |            |
|---------------------------------|------------|
| Display .....                   | 139        |
| Power saving mode .....         | 139        |
| Location and security .....     | 140        |
| Applications .....              | 141        |
| Accounts and sync .....         | 142        |
| Motion .....                    | 143        |
| Privacy .....                   | 143        |
| Storage .....                   | 143        |
| Language and keyboard .....     | 144        |
| Voice input and output .....    | 146        |
| Accessibility .....             | 148        |
| Date and time .....             | 149        |
| About phone .....               | 149        |
| <b>Troubleshooting .....</b>    | <b>150</b> |
| <b>Safety precautions .....</b> | <b>156</b> |
| <b>Index .....</b>              | <b>167</b> |

# Assembling

## Unpack

Check your product box for the following items:

- Mobile device
- Battery
- Quick start guide



Use only Samsung-approved software. Pirated or illegal software may cause damage or malfunctions that are not covered by your manufacturer's warranty.





- The items supplied with your device and available accessories may vary depending on your region or service provider.
- You can purchase additional accessories from your local Samsung dealer.
- The supplied accessories perform best for your device.
- Accessories other than the supplied ones may not be compatible with your device.

## Install the SIM or USIM card

When you subscribe to a cellular service, you will receive a Subscriber Identity Module (SIM) card, with subscription details, such as your personal identification number (PIN) and optional services. To use UMTS or HSDPA services, you can purchase a Universal Subscriber Identity Module (USIM) card.

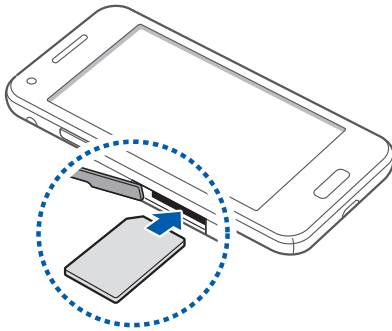
- 1 Open the cover of the SIM card slot.
- 2 Insert the SIM or USIM card with the gold-coloured contacts facing down.





-  Do not insert a memory card into the SIM card slot. If the memory card becomes lodged in the SIM card slot, you must take your device to a Samsung Service Centre to have the memory card removed.
- The SIM card slot of your device is only suited for standard SIM cards. Inserting a microSIM card or a microSIM card with an unauthorised holder may cause damage to the SIM card slot of your device.

- 3 Close the cover of the SIM card slot.

## Install the battery

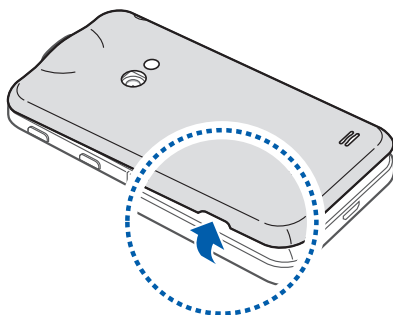
- 1 If the device is on, press and hold the Power key and select **Power off** → **OK** to turn it off.
- 2 Remove the back cover.



 Be careful not to damage your fingernails when you remove the back cover.

- 3 Insert the battery.

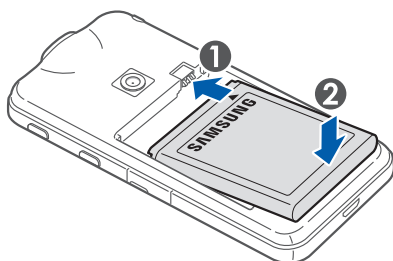

 The antenna is located in the upper area on the back of the device. Do not remove the protective tape covering the antenna, as this can damage the antenna.

#### 4 Replace the back cover.

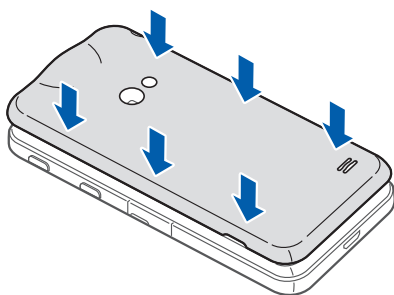



## Charge the battery

Before using the device for the first time, you must charge the battery.

You can charge the device with a travel adapter or by connecting the device to a PC with a USB cable.

 Use only Samsung-approved chargers and cables. Unauthorised chargers or cables can cause batteries to explode or damage your device.

-  • When your battery is low, the device will emit a warning tone and display a low battery message. The battery icon  will also be empty. If the battery level becomes too low, the device will automatically power off. Recharge your battery to continue using your device.
- If the battery is completely discharged, you cannot turn on the device, even with the travel adapter connected. Allow a depleted battery to charge for a few minutes before you try to turn on the device.

## › Charge with a travel adapter

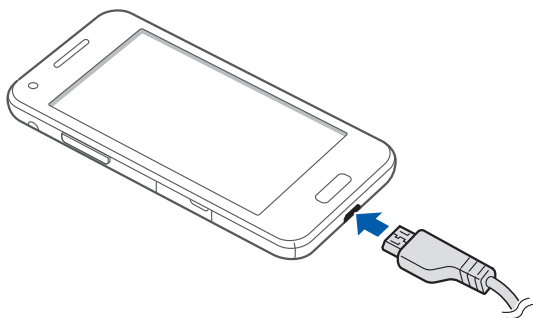

- 1 Plug the small end of the travel adapter into the multifunction jack.



-  Connecting the travel adapter improperly may cause serious damage to the device. Any damage caused by misuse is not covered by the warranty.

- 2 Plug the large end of the travel adapter into a power outlet.

- 
- You can use the device while it is charging, but it may take longer to fully charge the battery.
  - While the device is charging, the touch screen may not function due to an unstable power supply. If this happens, unplug the travel adapter from the device.
  - While charging, the device may heat up. This is normal and should not affect your device's lifespan or performance.
  - If your device is not charging properly, bring your device and the charger to a Samsung Service Centre.

- 3 When the battery is fully charged, first unplug the travel adapter from the device and then from the power outlet.
-  Do not remove the battery before removing the travel adapter. Doing this may cause damage to the device.
  -  To save energy, unplug the travel adapter when not in use. The travel adapter does not have a power switch, so you must unplug the travel adapter from the outlet when not in use to avoid wasting power. The device should remain close to the electrical socket while charging.

## › Charge with a USB cable

Before charging, ensure that your PC is turned on.

- 1 Plug one end (micro-USB) of the USB cable into the multifunction jack.
  - 2 Plug the other end of the USB cable into a USB port on a PC.
-  Depending on the type of USB cable you are using, it may take some time before charging begins.
- 3 When the battery is fully charged, first unplug the USB cable from the device and then from the PC.

## Insert a memory card (optional)

To store additional multimedia files, you must insert a memory card. Your device accepts microSD™ or microSDHC™ memory cards with maximum capacities of 32 GB (depending on memory card manufacturer and type).

 Samsung uses approved industry standards for memory cards, but some brands may not be fully compatible with your device. Using an incompatible memory card may damage your device or the memory card and can corrupt data stored on the card.

-  • Your device supports only the FAT file structure for memory cards. If you insert a card formatted with a different file structure, your device will ask you to reformat the memory card.
- Frequent writing and erasing of data will shorten the lifespan of memory cards.
- When you insert a memory card in your device, the file directory of the memory card will appear in the sdcard folder.



- 1 Open the cover of the memory card slot.
- 2 Insert a memory card with the gold-coloured contacts facing down.

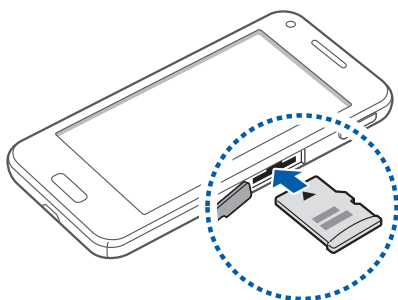

- 3 Push the memory card in the memory card slot until it locks in place.
- 4 Close the memory card cover.

## ➤ Remove the memory card

Before removing a memory card, first unmount it for safe removal.

- 1 In Idle mode, select **Applications** → **Settings** → **Storage** → **Unmount SD card** → **OK**.
- 2 Open the cover of the memory card slot.
- 3 Push the memory card gently until it disengages from the device.
- 4 Remove the memory card.
- 5 Close the memory card cover.

## › Format the memory card

Formatting your memory card on a PC may cause incompatibilities with your device. Format the memory card only on the device.

In Idle mode, select **Applications** → **Settings** → **Storage** → **Unmount SD card** → **OK** → **Format SD card** → **Format SD card** → **Erase everything**.



Before formatting the memory card, remember to make backup copies of all important data stored on your device. The manufacturer's warranty does not cover loss of data resulting from user actions.

# Getting started

## Turn your device on and off

To turn on your device, press and hold the Power key. If you turn on your device for the first time, follow the on-screen instructions to set up your device.

To turn off your device, press and hold the Power key and then select **Power off** → **OK**.



- Follow all posted warnings and directions from authorised personnel in areas where the use of wireless devices is restricted, such as aeroplanes and hospitals.
- To use your device's non-network services only, switch to Flight mode. Press and hold the Power key and select **Flight mode**.

# Get to know your device

## > Device layout

### Front view

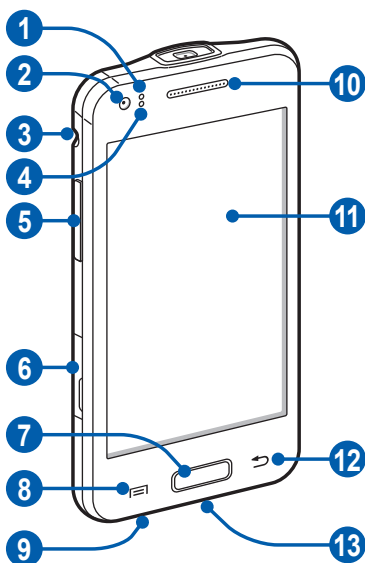

| Number | Function          |
|--------|-------------------|
| 1      | Light sensor      |
| 2      | Front camera lens |
| 3      | Headset jack      |
| 4      | Proximity sensor  |
| 5      | Volume key        |
| 6      | SIM card slot     |

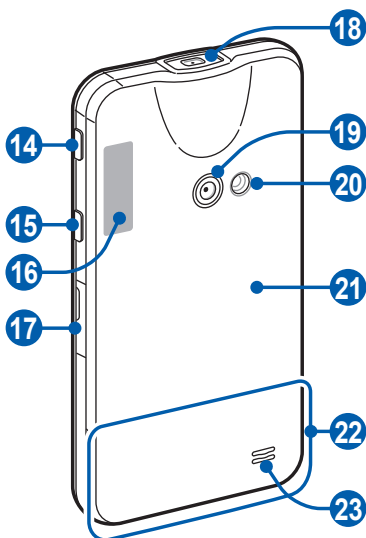

| Number | Function           |
|--------|--------------------|
| 7      | Home key           |
| 8      | Menu key           |
| 9      | Microphone         |
| 10     | Earpiece           |
| 11     | Touch screen       |
| 12     | Back key           |
| 13     | Multifunction jack |

## Rear view







| Number | Function                 |
|--------|--------------------------|
| 14     | Projector key            |
| 15     | Power/Reset/Lock key     |
| 16     | GPS antenna <sup>1</sup> |
| 17     | Memory card slot         |
| 18     | Projector lens           |
| 19     | Rear camera lens         |
| 20     | Flashbulb                |
| 21     | Back cover               |
| 22     | Main antenna             |
| 23     | Speaker                  |

## › Keys





| Key  | Function   |
|--|--|
|  Power/<br>Reset <sup>2</sup> /<br>Lock | Turn on the device (press and hold); Access the quick menus (press and hold); Reset the device (press and hold for 8-10 seconds); Lock the touch screen. |
|  Projector                            | Access the projector quick menu while the projector is on; Turn the projector on or off (press and hold).  |



















1. Do not touch or cover the area around the antenna with your hands or other objects while using the GPS functions.
2. If your device has fatal errors or hang-ups, or freezes, you may need to reset the device to regain functionality.

| Key  | Function  |
|--|---|
|  Menu   | Open a list of options available on the current screen; In Idle mode, open the Google search application (press and hold); Open the search input window while using some applications (press and hold). |
|  Home    | Return to the idle screen; Open the list of recent applications (press and hold); Launch the voice talk application (press twice).  |
|  Back   | Return to the previous screen.  |
|  Volume | Adjust the device's volume.   |















## › Indicator icons

 Icons shown on the display may vary depending on your region or service provider.

| Icon  | Definition             |
|---|------------------------|
|  | No signal              |
|  | Signal strength        |
|  | GPRS network connected |
|  | EDGE network connected |
|  | UMTS network connected |

| Icon  | Definition                     |
|---|--------------------------------|
|    | Open Wi-Fi APs available       |
|    | Wi-Fi AP connected             |
|    | Wi-Fi Direct connected         |
|    | Bluetooth activated            |
|    | Bluetooth headset connected    |
|    | GPS activated                  |
|    | Call in progress               |
|    | Call on hold                   |
|    | Speakerphone activated         |
|    | Missed call                    |
|    | Synchronised with the web      |
|    | Uploading data                 |
|    | Downloading data               |
|  | Call diverting activated       |
|  | Connected to PC                |
|  | USB tethering activated        |
|  | Wi-Fi tethering activated      |
|  | No SIM or USIM card            |
|  | New text or multimedia message |



| Icon   | Definition                               |
|--|--|
|   | New email message                        |
|   | New voice mail message                   |
|   | Alarm activated                          |
|   | Event notification                       |
|   | Roaming (outside of normal service area) |
|   | Silent mode activated                    |
|   | Vibration mode activated                 |
|   | Flight mode activated                    |
|   | Music playback in progress               |
|   | Music playback paused                    |
|   | FM radio turned on in the background     |
|   | Error occurred or caution required       |
|   | Battery power level                      |
|  | Current time                             |

## Use the touch screen

Your device's touch screen lets you easily select items or perform functions. Learn basic actions to use the touch screen.



- To avoid scratching the touch screen, do not use sharp tools.
- Do not allow the touch screen to come into contact with other electrical devices. Electrostatic discharges can cause the touch screen to malfunction.
- Do not allow the touch screen to come into contact with water. The touch screen may malfunction in humid conditions or when exposed to water.



- For optimal use of the touch screen, remove the screen protection film before using your device.
- Your touch screen has a layer that detects small electrical charges emitted by the human body. For best performance, tap the touch screen with your fingertip. The touch screen will not react to touches of sharp tools, such as a stylus or pen.

Control your touch screen with the following actions:

- Tap: Touch once with your finger to select or launch a menu, option, or application.
- Tap and hold: Tap an item and hold it for more than 2 seconds to open a pop-up option list.
- Drag: Tap and drag your finger up, down, left, or right to move to items on lists.
- Drag and drop: Tap and hold your finger on an item, and then drag your finger to move the item.

- Double-tap: Tap twice quickly with your finger to zoom in or out while viewing photos or web pages.
-  • Your device turns off the touch screen when you do not use the device for a specified period. To turn on the screen, press the Power key or the Home key.
- You can also adjust the backlight time. In Idle mode, open the application list and select **Settings** → **Display** → **Screen timeout**.

## Lock or unlock the touch screen and keys

You can lock the touch screen and keys to prevent any unwanted device operations.

To lock, press the Power key. To unlock, turn on the screen by pressing the Power key or the Home key, tap anywhere on the screen, and then drag your finger outside of the large circle.

-  You can activate the screen lock feature to prevent others from using or accessing your personal data and information saved in your device. ► p. 35

## Get to know the idle screen

When the device is in Idle mode, you will see the idle screen. From the idle screen, you can view indicator icons, widgets, shortcuts to applications, and other items.

The idle screen has multiple panels. Scroll left or right to a panel of the idle screen. You can also select a dot at the bottom of the screen to move directly to the corresponding screen.

## › Add items to the idle screen

You can customise the idle screen by adding shortcuts to applications or items in applications, widgets, or folders. To add items to the idle screen,

- 1 Press [≡] → **Add** or tap and hold the empty area on the idle screen.
- 2 Select the item category → an item:
  - **Widgets:** Add widgets to the idle screen.
  - **Shortcuts:** Add shortcuts to items, such as applications, bookmarks, and contacts.
  - **Folders:** Add a new folder or a shortcut folder.
  - **Wallpapers:** Set a background image.

## › Move items on the idle screen

- 1 Tap and hold an item to move.
- 2 Drag the item to the location you want.

## › Remove items from the idle screen

- 1 Tap and hold an item to remove.  
The trash bin appears at the bottom of the idle screen.
- 2 Drag the item to the trash bin.
- 3 When the item turns red, release the item.

## › Use the notifications panel

In Idle mode or while using an application, tap the indicator icons area and drag your finger down to open the notifications panel. You can activate or deactivate wireless connection features and access a list of notifications, such as messages, calls, events or processing status. To hide the panel, drag the bottom of the list up.

From the notifications panel, you can use the following options:

- **Wi-Fi:** Activate or deactivate the Wi-Fi feature. ► p. 108
- **Bluetooth:** Activate or deactivate the Bluetooth wireless connection feature. ► p. 105
- **GPS:** Activate or deactivate the GPS feature.
- **Silent mode:** Activate or deactivate Silent mode.
- **Auto rotation:** Activate or deactivate the auto rotation.



Available options may vary depending on your region or service provider.

## › Add or remove panels to the idle screen

You can add or remove panels of the idle screen to organise widgets according to your preferences and needs.

1 In Idle mode, press [≡] → **Edit**.

You can also place your two fingers on the screen and pinch to switch to Edit mode.

2 Add or remove panels by using the following features:

- To remove a panel, tap and hold the thumbnail of a panel and drag it to the trash bin at the bottom of the screen.

- To add a new panel, select .
- To change the order of the panels, tap and hold the thumbnail of a panel and drag it to the location you want.

3 When you are finished, press [.

## Access applications

To access your device's applications,

1 In Idle mode, select **Applications** to access the application list.

2 Scroll left or right to another application screen.

You can also select a dot at the bottom of the screen to move directly to the corresponding screen.

3 Select an application.



- When you use applications provided by Google, you must have a Google account. If you do not have a Google account, sign up for a Google account.
- You can add a shortcut to an application by tapping and holding the application icon from the application list. You can move the icon to the location you want on the idle screen.

4 Press [] to return to the previous screen; Press the Home key to return to the idle screen.



- If you rotate the device while using some features, the interface will automatically rotate as well. To prevent the interface from rotating, open the notifications panel and select **Auto rotation**.
- While using the device, you can capture an image of a screen by pressing and holding Home key and the Power key simultaneously. The image will be saved in **My files** → **ScreenCapture**.

## › Organise applications

You can reorganise the applications in the application list by changing their order or grouping them into categories to suit your preferences and needs.

- 1 In the application list, press [≡] → **Edit** → **OK**.
- 2 Tap and hold an application.
- 3 Drag the application icon to the location you want.  
You can move an application icon to another main menu screen. You can also move most-used applications next to **Home**.
- 4 Press [≡] → **Save**.

To add a folder or panel to the menu screen,

- 1 In the application list, press [≡] → **Edit**.
- 2 Tap and hold an application.
- 3 Drag the application icon to **Add Folder** or **Add Page** at the bottom of the screen.
- 4 Repeat steps 2-3 to add more applications.

- 5 Drag **Add Folder** or **Add Page** to the menu screen.  
A new folder or panel containing the applications is added to the menu screen.
- 6 If you added a folder, enter a name and select **OK**.
- 7 Press [≡] → **Save**.

To change the order of the main menu screens,

- 1 In the application list, place your two fingers on the screen and pinch.
- 2 Tap and hold the thumbnail of a screen and drag it to the location you want.

## › Access recent applications

- 1 Press and hold the Home key to view the applications you have accessed recently.
- 2 Select an application to access.

## › Use the task manager

Your device is a multitasking device. It can run more than one application at the same time. However, multitasking may cause hang-ups, freezing, memory problems, or additional power consumption. To avoid these problems, end unnecessary programs using the task manager.

- 1 In Idle mode, open the application list and select **Task manager** → **Active applications**.  
The list of all the applications currently running on your device appears.
- 2 To close an application, select **Exit**.  
To close all active applications, select **Exit all**.



## Customise your device

Get more from your device by customising it to match your preferences.

### › Set the current time and date

- 1 In Idle mode, open the application list and select **Settings** → **Date and time**.
- 2 Set the time and date and change other options.

### › Turn on or off the touch tone

In Idle mode, open the application list and select **Settings** → **Sound** → **Audible selection**.

### › Adjust the volume of the ringtones

Press the Volume key up or down to adjust the ringtone volume.

### › Switch to Silent mode

To mute or unmute your device, do one of the following:

- In Idle mode, open the application list and select **Phone** → **Keypad** and tap and hold #.
- Open the notifications panel from the top of the screen and select **Silent mode**.
- Press and hold the Power key and select **Silent mode**.



You can set the device to alert you to various events in Silent mode. In Idle mode, open the application list and select **Settings** → **Sound** → **Vibration** → **Always** or **Only in Silent mode**.

## › Change your ringtone

- 1 In Idle mode, open the application list and select **Settings** → **Sound** → **Phone ringtone**.
- 2 Select a ringtone from the list and select **OK**.

## › Activate animation for switching windows

In Idle mode, open the application list and select **Settings** → **Display** → **Animation** → **Some animations** or **All animations**.

## › Select a wallpaper for the idle screen

- 1 In Idle mode, press [≡] → **Wallpaper** → an option.
- 2 Select an image.
- 3 Select **Save** or **Set wallpaper**.



Samsung is not responsible for any use of default images or wallpapers provided on your device.

## › Adjust the brightness of the display

- 1 In Idle mode, open the application list and select **Settings** → **Display** → **Brightness**.
- 2 Clear the check box next to **Automatic brightness**.
- 3 Drag the slider to adjust the level of brightness.
- 4 Select **OK**.



The brightness level of the display will affect how quickly the device consumes battery power.

## › Set a screen lock

You can lock the touch screen by activating the screen lock feature. Your device will require the unlock code each time you turn on the device or unlock the touch screen.



- If you forget your unlock code, bring your device to a Samsung Service Centre to reset it.
- Samsung is not responsible for any loss of security codes or private information or other damages caused by illegal software.

## Set an unlock pattern

- 1 In Idle mode, open the application list and select **Settings** → **Location and security** → **Set up screen lock** → **Pattern**.
- 2 See the on-screen instructions and example patterns and select **Next**.
- 3 Draw a pattern by dragging your finger to connect at least 4 dots and select **Continue**.
- 4 Draw the pattern again and select **Confirm**.

## Set an unlock PIN code

- 1 In Idle mode, open the application list and select **Settings** → **Location and security** → **Set up screen lock** → **PIN**.
- 2 Enter a new PIN (numeric) and select **Continue**.
- 3 Enter the PIN again and select **OK**.

## Set an unlock password

- 1 In Idle mode, open the application list and select **Settings** → **Location and security** → **Set up screen lock** → **Password**.
- 2 Enter a new password (alphanumeric) and select **Continue**.
- 3 Enter the password again and select **OK**.

## › Lock your SIM or USIM card

You can lock your device by activating the PIN supplied with your SIM or USIM card.

- 1 In Idle mode, open the application list and select **Settings** → **Location and security** → **Set up SIM card lock** → **Lock SIM card**.
- 2 Enter your PIN and select **OK**.

Once the PIN lock is enabled, you must enter the PIN each time you turn on the device.



- If you enter an incorrect PIN too many times, your SIM or USIM card will be blocked. You must enter a PIN unlock key (PUK) to unblock the SIM or USIM card.
- If you block your SIM or USIM card by entering an incorrect PUK, bring the card to your service provider to unblock it.

## › Activate the Find my mobile feature

When someone inserts a new SIM or USIM card in your device, the Find my mobile feature will automatically send the contact number to specified recipients to help you locate and recover your device.

To use this feature, you need a Samsung account for controlling the device from the web remotely.

- 1 In Idle mode, open the application list and select **Settings** → **Location and security** → **SIM change alert**.
- 2 Select **Sign in**, enter your email address and password for your Samsung account, and select **Sign in**.  
To create a Samsung account, select **Sign up**.
- 3 Select **Alert message recipients**.
- 4 Enter the password for your Samsung account again and select **OK**.
- 5 Enter a phone number including a country code (with +).
- 6 Enter the text message to be sent to the recipients.
- 7 Select **Done**.

## Enter text

You can enter text by selecting characters on the virtual keypad or by inputting handwriting on the screen.

-  You cannot enter text in some languages. To enter text, you should change the writing language to one of the supported languages. ► p. 144

## › Change the keyboard type

You can change the keyboard type. Tap and hold the text input field and select **Input method** → a keyboard type (Samsung keypad or Swype).

## › Enter text using the Swype keyboard

- 1 Select the first character of a word and drag your finger to the second character without releasing the finger from the screen.
- 2 Continue until you have finished the word.





- 3 Release the finger on the last character.
- 4 When the word displays correctly, select  to insert a space. If the correct word does not display, select an alternative word from the list that appears.
- 5 Repeat steps 1-4 to complete your text.

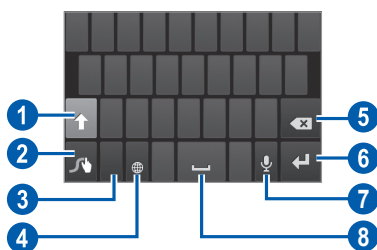

- You can also tap the keys to enter text.
- You can tap and hold a key to enter characters on the upper half of the key. When you tap and hold a key until the character list appears, you can enter special characters and symbols.

You can also use the following keys:



| Number | Function   |
|--------|--|
| 1      | Change case.   |
| 2      | Enter the recommended word or add a new word to the dictionary; Access the keypad settings (tap and hold).   |
| 3      | Switch between Symbol/Number mode and ABC mode.  |
| 4      | Change the input language.   |
| 5      | Clear your input.  |
| 6      | Start a new line.  |
| 7      | Enter text by voice.<br> This feature may be unavailable depending on the selected input language. |
| 8      | Insert a space.  |

## › Enter text using the Samsung keypad

1 Select  → **Portrait keypad types** and select a text input method.

You can select one of key input methods (QWERTY or traditional keypad) or handwriting input methods.

2 Enter text by selecting alphanumeric keys or writing on the screen.

You can also use the following keys:

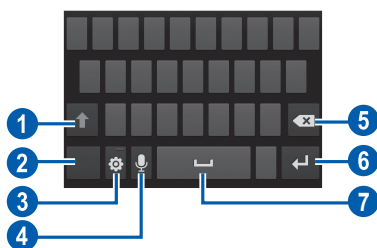





| Number | Function  |
|--------|---|
| 1      | Change case.  |
| 2      | Switch between Symbol/Number mode and ABC mode.   |
| 3      | Access the keypad settings; Change the keyboard type (tap and hold).  |
| 4      | Enter text by voice. This icon is available only when you activate the voice input feature for the Samsung keypad.<br> This feature may be unavailable depending on the selected input language. |
| 5      | Clear your input.   |
| 6      | Start a new line.   |
| 7      | Insert a space.   |



## › Copy and paste text

While you are entering text, you can use the copy and paste feature to use text in other applications.

- 1 Place the cursor on the text you want to copy.
- 2 Select .
- 3 Select **Select word** or **Select all** to select the text you want.
- 4 Drag  or  to select the text you want.
- 5 Select **Copy** to copy, or **Cut** to cut the text onto the clipboard.
- 6 In another application, place the cursor where you want to paste the text.
- 7 Select  → **Paste** to insert the text from the clipboard into the text field.

## Download applications from Play Shop (Play Store)

Based on the Android platform, your device's functionality can be extended by installing additional applications.

Play Shop provides you an easy and quick way to shop for games and mobile applications.



- This feature may be unavailable depending on your region or service provider.
- Your device will save user files from downloaded applications to the internal memory.

## › Install an application

- 1 In Idle mode, open the application list and select **Play Shop (Play Store)**.
- 2 Select **Accept** when the terms and conditions appear.
- 3 Search for a file or application and download it.

## › Uninstall an application

- 1 From the Play Shop home screen, press [☰] → **My Apps**.
- 2 Select the item you want to delete.
- 3 Select **Uninstall** → **OK**.

## Download files from the web

When you download files or web applications from the web, your device saves them in a memory card.

 Files you download from the web can include viruses that will damage your device. To lessen your risk, only download files from sources you trust.

 Some media files include Digital Rights Management to protect copyrights. This protection may prevent you from downloading, copying, modifying, or transferring some files.

To download files from the web,

- 1 In Idle mode, open the application list and select **Internet**.
- 2 Search for a file or application and download it.

To install applications downloaded from websites other than Play Shop, you must select **Settings** → **Applications** → **Unknown sources** → **OK**.

## Synchronise data

You can synchronise data with various web servers and back up or restore your data.

Once the synchronisation is completed, your device stays connected to the web. If any change is made on the web, the updated information will appear on your device and will automatically begin synchronisation, and vice versa.



This feature may be unavailable depending on your region or service provider.

### › Set up a server account

- 1 In Idle mode, open the application list and select **Settings** → **Accounts and sync**.
- 2 Select **Add account** → an account type.
- 3 Follow the on-screen instructions to complete the account setup.

### › Activate automatic sync

- 1 In Idle mode, open the application list and select **Settings** → **Accounts and sync**.
- 2 Select **Auto-sync**.
- 3 Select an account.
- 4 Select the applications you want to synchronise.

To exclude applications from automatic synchronisation, clear the check boxes next to the applications you want.

## › Synchronise data manually

- 1 In Idle mode, open the application list and select **Settings** → **Accounts and sync**.
- 2 Select an account.
- 3 Select **Sync now**. Your device will start synchronising the data you set for synchronisation.

# Communication

## Calling

Learn to use calling functions, such as making and answering calls, using options available during a call or customising and using call-related features.



### › Make or answer a call

You can use the buttons or the touch screen when you make, accept, end or reject calls.



- When you turn on the proximity sensor, your device automatically turns off and locks the touch screen to prevent accidental inputs when you hold the device near your face. ► p. 137
- Static electricity discharged from your body or clothing may interfere with the proximity sensor during a call.

### Make a call

- 1 In Idle mode, open the application list and select **Phone** → **Keypad**, and enter an area code and a phone number.
- 2 Select  to make a voice call.  
For a video call, select .
- 3 To end the call, select **End call**.



- Use the phonebook to save numbers you dial frequently. ► p. 84
- To quickly access the call log to redial the numbers you dialled recently, select **Phone** → **Logs**.

## Answer a call

1 When a call comes in, drag  outside of the large circle.

 When the device is ringing, press the Volume key to mute the ringtone.

2 To end the call, select **End call**.

## Reject a call

When a call comes in, drag  outside of the large circle.

To send a message when you reject incoming calls, select **Reject call with message**.

 First set a text message to be sent to callers. In Idle mode, open the application list and select **Settings** → **Call** → **Set reject messages**.

## Call an international number

1 In Idle mode, open the application list and select **Phone** → **Keypad**, and tap and hold **0** to insert the + character.

2 Enter the complete number you want to dial (country code, area code and phone number), and then select  to dial the number.



## › Use a headset

By plugging a headset into the device, you can answer and control calls hands-free:

- To answer a call, press the headset button.
- To reject a call, press and hold the headset button.
- To place a call on hold or retrieve a held call during a call, press and hold the headset button.
- To end a call, press the headset button.

## › Use options during a voice call

You can use the following options while a voice call is in progress:

- To adjust the voice volume, press the Volume key up or down.
- To place a call on hold, select . To retrieve a held call, select .
- To dial a second call, select **Add call** and then dial a new number.
- To answer a second call, drag  outside of the large circle when a call waiting tone sounds. The device asks whether to end or hold the first call. You must subscribe to the call waiting service to use this feature.
- To open the dialling screen, select **Keypad**.
- To activate the speakerphone feature, select **Speaker**.



In noisy environments, you may have difficulty hearing some calls while using the speakerphone feature. For better audio performance, use the normal phone mode.

- To turn off the microphone so that the other party cannot hear you, select **Mute**.
- To listen and talk to the other party via a Bluetooth headset, select **Headset**.
- To open the phonebook, press [☰] → **Contacts**.
- To add a memo, press [☰] → **Memo**.
- To switch between the two calls, select **Swap**.
- To make a multiparty call (conference call), make or answer a second call and select **Merge** when connected to the second party. Repeat to add more parties. You must subscribe to the multiparty call service to use this feature.

## › Use options during a video call

You can use the following options while a video call is in progress:

- To switch between the front and rear camera lens, select **Switch Camera**.
- To turn off the microphone so that the other party cannot hear you, select **Mute**.
- To hide your image from the other party, press [≡] → **Hide me**.
- To select an alternative image to be shown to the other party, press [≡] → **Outgoing image**.
- To open the dialling screen, press [≡] → **Dialpad**.
- To listen and talk to the other party via a Bluetooth headset, press [≡] → **Switch to headset**.
- To activate the speakerphone feature, press [≡] → **Speaker On/Off**.
- To use the other party's image, tap and hold the other party's image. You can capture an image of the screen or record the video call.

## › View and dial missed calls

Your device will display calls you have missed on the display. To dial the number of a missed call, open the notifications panel and select the missed call.



## › Use additional features

You can use various other call-related features, such as auto rejection, Fixed Dialling Number (FDN) mode, or call diverting or barring.

### Set auto rejection

Use auto rejection to reject calls from certain numbers automatically. To activate auto rejection and create auto reject lists,

1 In Idle mode, open the application list and select **Settings** → **Call** → **Call rejection**.

2 Select **Auto reject mode** → an option.

| Option              | Function   |
|---------------------|--|
| All numbers         | Reject all calls.  |
| Auto reject numbers | Reject calls from phone numbers on the auto reject list. |

3 Select **Auto reject list**.

4 Select **Add** and enter a phone number.

5 Select **Match criteria** → an option (if necessary).

6 Select **Save**.

7 To add more numbers, repeat steps 4-6.

## Use Fixed Dialling Number (FDN) mode

In FDN mode, your device will restrict outgoing calls, except for the numbers stored in the FDN list. To activate FDN mode,

- 1 In Idle mode, open the application list and select **Settings** → **Call** → **Additional settings** → **Fixed Dialling Numbers** → **Enable FDN**.
- 2 Enter the PIN2 supplied with your SIM or USIM card and select **OK**.
- 3 Select **FDN list** and add contacts to be used in FDN mode.

## Set call forwarding

Call diverting is a network feature to send incoming calls to another number that you specify. You can set this feature separately for several conditions when you are not able to answer calls, such as when you are already on the phone or when you are outside of the service area.

- 1 In Idle mode, open the application list and select **Settings** → **Call** → **Call forwarding** → a call type.
- 2 Select a condition.
- 3 Enter a number to which calls will be forwarded and select **Enable**.  
Your setting will be sent to the network.

## Set call barring

Call barring is a network feature to restrict certain types of calling or to prevent others from making calls with your device.

- 1 In Idle mode, open the application list and select **Settings** → **Call** → **Additional settings** → **Call barring** → a call type.
- 2 Select a call barring option.
- 3 Enter a call barring password and select **OK**.  
Your setting will be sent to the network.



## Set call waiting

Call waiting is a network feature to alert you of an incoming call while you are on a previous call. This feature is available only for voice calls.

In Idle mode, open the application list and select **Settings** → **Call** → **Additional settings** → **Call waiting**. Your setting will be sent to the network.

## › View call logs

You can view logs of your calls filtered by their types.

- 1 In Idle mode, open the application list and select **Phone** → **Logs**.
- 2 Press [≡] → **View by** → an option to sort the call logs.  
 From the call logs, you can make a call or send a message directly to a contact by quickly flicking the contact to the left or right.
- 3 Select a log to view its details.  
 From the detail view, you can dial the number, send a message to the number or add the number to the phonebook or auto reject list.

## Messaging

Learn to create and send text (SMS) or multimedia (MMS) messages, and view or manage messages you have sent or received.



You may incur additional charges for sending or receiving messages while outside your home service area. For details, contact your service provider.

### › Send a text message

- 1 In Idle mode, open the application list and select **Messaging**.
- 2 Select
- 3 Add recipients of your message.
  - Enter phone numbers manually and separate them by inserting a semicolon or a comma.
  - Select phone numbers from the lists by selecting
- 4 Select **Tap to enter message** and enter your message text.  
To insert emoticons, press [☺] → **Insert smiley**.
- 5 Select **Send** to send the message.

### › Send a multimedia message

- 1 In Idle mode, open the application list and select **Messaging**.
- 2 Select

- 3 Add recipients of your message.
  - Enter phone numbers or email addresses manually and separate them by inserting a semicolon or a comma.
  - Select phone numbers or email addresses from the lists by selecting .



When you enter an email address, the device will convert the message as a multimedia message.

- 4 Press [≡] → **Add subject** and enter a subject for the message.
- 5 Select **Tap to enter message** and enter your message text.  
To insert emoticons, press [≡] → **Insert smiley**.
- 6 Select  and add an item.  
You can select a file from the file list or create a new photo, video, or sound.
- 7 Select **Send** to send the message.

## ➤ View a text or multimedia message

- 1 In Idle mode, open the application list and select **Messaging**.  
Your messages are grouped into message threads by contact, like a messenger.
- 2 Select a contact.
- 3 For a multimedia message, select a message to view the details.

## › Listen to voice mail messages

If you have set missed calls to be diverted to the voice mail server, callers may leave voice messages when you do not answer incoming calls. To access your voice mail inbox and listen to voice mail messages,

- 1 In Idle mode, open the application list and select **Phone** → **Keypad** and then tap and hold **1**.
- 2 Follow the instructions from the voice mail server.



You must save the voice mail server number before accessing the server. Your service provider can give you the number.

## Google Mail

You can retrieve new email messages from Google Mail™ to your Inbox. When you access this application, the Inbox screen appears. The total number of unread messages displays in the title bar and unread messages display in bold.



- This feature may be unavailable depending on your region or service provider.
- This Google Mail menu may be labelled differently depending on your service provider.

## › Send an email message







- 1 In Idle mode, open the application list and select **Google Mail**.
- 2 If you are launching this application for the first time, select **OK**.

- 3 Press [≡] → **Compose**.
- 4 Enter a name or address in the recipient field.
- 5 Enter a subject and message.
- 6 To attach an image file, press [≡] → **Attach** → a file.
- 7 Select  to send the message.

## › View email messages

- 1 In Idle mode, open the application list and select **Google Mail**.
- 2 Select an email message.

From the message view, use the following options:

- To reply to the message, select .
- To reply to the message including all recipients, select  → **Reply all**.
- To forward the message to other people, select  → **Forward**.
- To add a star to the message, select .
- To view an attachment, select **Preview**. To save it to your device, select **Download**.
- To archive the message, select **Archive**.
- To delete the message, select **Delete**.
- To move to the next or previous message, select  or .

## › Organise email by labels

You can organise your email by labelling your messages. You can sort messages by label filter.

## Add a label to a message

- 1 From the Inbox screen, tap and hold a message.
- 2 Select **Change labels**.
- 3 Select a label to add and select **OK**.

## Filter messages

- 1 From the Inbox screen, press [☰] → **Go to labels**.
- 2 Select the label of the messages you want to view.

## Email

Learn to send or view email messages via your personal or company email account.





### › Set up an email account

- 1 In Idle mode, open the application list and select **Email**.
- 2 Enter your email address and password.
- 3 Select **Next** (for general email accounts, such as Google Mail and Yahoo) or **Manual setup** (for other company email accounts).
- 4 Follow the on-screen instructions.

When you are finished setting up the email account, the email messages are downloaded to your device. If you have created more than two accounts, you can switch between email accounts; Select an account name at the top left of the screen and select one you want to retrieve messages from.



## › Send an email message









- 1 In Idle mode, open the application list and select **Email**.
- 2 Select .
- 3 Add recipients of your message.
  - Enter email addresses manually and separate them by inserting a semicolon or a comma.
  - Select email addresses from the lists by selecting .
  - To add more recipients, press [≡] → **Add Cc/Bcc**.
- 4 Select the subject field to enter a subject.
- 5 Select the text input field to enter your email text.
- 6 Select **Attach** and attach a file.  
 You cannot attach Digital Rights Management (DRM)-protected files.
- 7 Select **Send** to send the message.  
 If you are offline or outside your service area, the message will be held in the message thread list until you are online and in your service area.

## › View an email message

When you open an email account, you can view previously retrieved emails offline or connect to the email server to view new messages. After retrieving email messages, you can view them offline.

- 1 In Idle mode, open the application list and select **Email** → an email account.
- 2 Press [≡] → **Refresh** to update the message list.
- 3 Select an email message.

From the message view, use the following options:

- To move to the next or previous message, select  or .
- To move the message to another folder, select .
- To delete the message, select .
- To reply to the message, select  → **Reply**.
- To forward the message to other people, select  → **Forward**.
- To view an attachment, select  next to the attachment field and select the attachment. To save it to your device, select .

## Talk

Learn to chat with friends and family via Google Talk™.



This feature may be unavailable depending on your region or service provider.

### › Add friends to your friend list

- 1 In Idle mode, open the application list and select **Talk**. The friend list shows all of your Google Talk contacts at a glance.
- 2 Press [] → **Add friend**.
- 3 Enter an email address of the friend and select **Send invitation**.

When your friend accepts the invitation, the friend is added to your friend list.

## › Start a chat

- 1 In Idle mode, open the application list and select **Talk**.
- 2 Select a friend from the friend list. The chat screen opens.
- 3 Enter your message and select **Send**.  
To insert emoticons, press [☺] → **More** → **Insert smiley**.
- 4 To switch between active chats, press [☺] → **Switch chats**.
- 5 To end the chat, press [☺] → **End chat**.

## ChatON

Learn to chat with your friends and family in ChatON. This is an instant messenger based on mobile phone numbers, regardless device type or operating system. While having a conversation with your contacts, you can send various multimedia files and data, such as photos, videos, and contact numbers, animated messages.

- 1 In Idle mode, open the application list and select **ChatON**.
- 2 If you are launching this application for the first time, select a region → **Next**. Then read the terms and conditions and select **Accept**.
- 3 Follow the on-screen instructions to complete the account setup.
- 4 Chat with friends and family instantly.

## Messenger

Learn to send and receive instant messages from friends and family with the Google+ messenger instant messaging service.

1 In Idle mode, open the application list and select **Messenger**.



If you are launching this application for the first time, follow the on-screen instructions to complete the account setup.

2 Enter and send your message.

## Google+

Learn to access Google's social network service. You can create groups to send and receive instant messages and upload your photos.

1 In Idle mode, open the application list and select **Google+**.



If you are launching this application for the first time, follow the on-screen instructions to complete the account setup.

2 Select a social network feature.

## Social Hub

Learn to access Social Hub™, the integrated communication application for Social Network Service (SNS), email, messages, instant messages, contacts or calendar information. Visit [socialhub.samsungapps.com](http://socialhub.samsungapps.com) for more details.

- 1 In Idle mode, open the application list and select **Social Hub**.
- 2 Check and use contents delivered from Social Hub.

# Entertainment

## Camera

Learn how to capture and view photos and videos. You can take photos at resolutions up to 2560 x 1920 pixels (5 megapixels) and videos at resolutions up to 1280 x 720 pixels.





- The camera automatically turns off when you do not use it for a specified period.
- The memory capacity may differ depending on the shooting scene or shooting conditions.

### › Capture a photo

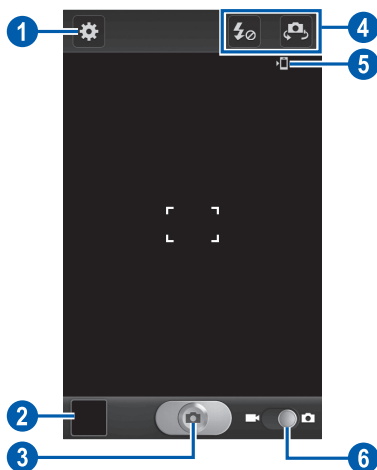
- 1 In Idle mode, open the application list and select **Camera** to turn on the camera.
- 2 Aim the lens at the subject and make any necessary adjustments.



| Number | Function  |
|--------|---|
| 1      | Change the camera settings.   |
| 2      | Open the image viewer to view photos you captured.  |
| 3      | Capture a photo.  |
| 4      | <p>Use camera shortcuts.</p> <ul style="list-style-type: none"> <li>• : Change the flash setting.</li> <li>• : Switch between the front and rear camera lenses.</li> </ul> <p>You can add or remove shortcuts to frequently used options. ► p. 72</p> |
| 5      | View default storage location   |
| 6      | Switch to the camcorder.  |

- 3 Tap where you want to focus on the preview screen. The focus frame moves to the place you tap and changes to green when the subject is in focus.
- 4 Select  to take a photo. The photo is saved automatically.

After taking photos, select the image viewer icon to view the taken photos.



- To view more photos, scroll left or right.
- To zoom in, place two fingers on the screen and spread them apart. To zoom out, move your fingers closer together. You can also double-tap the screen.
- To send a photo to others, select **Share**.
- To delete a photo, select **Delete**.

- To use additional features with a photo, select **More** and use the following options:
  - **Set as**: Set a photo as wallpaper or a caller ID image for a contact.
  - **Rename**: Rename a photo file.

## ▶ Capture a photo by using preset options for various scenes



Your camera provides you with predefined settings for various scenes. You can simply select the proper mode for your shooting conditions and subjects.

For example, when you take photos at night, select the night mode that uses an extended exposure.

- 1 In Idle mode, open the application list and select **Camera** to turn on the camera.
- 2 Select  → **Scene mode** → a scene.
- 3 Press [].
- 4 Make any necessary adjustments.
- 5 Select  to take a photo.

## ▶ Capture a photo in Self shot mode



You can take photos of yourself conveniently using the front camera lens.

- 1 In Idle mode, open the application list and select **Camera** to turn on the camera.
- 2 Select  → **Self portrait**.
- 3 Make any necessary adjustments.
- 4 Select  to take a photo.





## › Capture a photo in Smile shot mode

Your camera can recognise people's faces and help you take photos of their smiling faces.

- 1 In Idle mode, open the application list and select **Camera** to turn on the camera.
- 2 Select  → **Shooting mode** → **Smile shot**.
- 3 Make any necessary adjustments.
- 4 Aim the camera lens at your subject and select . Your device recognises people in an image and detects their smiles. When the subject smiles, the device automatically takes a photo.



## › Capture a panoramic photo

You can take wide panoramic photos using Panorama shooting mode. This mode is convenient for photographing landscapes.

- 1 In Idle mode, open the application list and select **Camera** to turn on the camera.
- 2 Select  → **Shooting mode** → **Panorama**.
- 3 Make any necessary adjustments.
- 4 Select  to take the first photo.
- 5 Slowly move the device in any direction and align the green frame with the viewfinder. When you have aligned the green frame and viewfinder, the camera will automatically take the next photo.
- 6 Repeat step 5 to complete the panoramic photo.



## › Capture a photo of action

You can capture shots of a moving subject and then combine them into a single photo that shows the action.

- 1 In Idle mode, open the application list and select **Camera** to turn on the camera.
- 2 Select  → **Shooting mode** → **Action shot**.
- 3 Make any necessary adjustments.
- 4 Select  to capture the first photo.
- 5 Move the device to follow the moving subject.  
The device automatically captures the next photos.
- 6 Continue to follow the subject until the device has captured all the shots necessary for the action photo.

## › Capture a photo in Cartoon mode

You can take photos with cartoon effects.

- 1 In Idle mode, open the application list and select **Camera** to turn on the camera.
- 2 Select  → **Shooting mode** → **Cartoon**.
- 3 Make any necessary adjustments.
- 4 Select  to take a photo.

## › Customise camera settings

Before taking a photo, select  to access the following options:



| Option         | Function   |
|----------------|--|
| Edit shortcuts | Add or remove shortcuts to frequently used options.  |
| Self portrait  | Switch between the front and rear camera lenses.   |
| Flash          | Change the flash setting; You can manually turn the flash on or off, or set the camera to automatically use the flash when needed. |
| Shooting mode  | Change the shooting mode.  |
| Scene mode     | Change the scene mode.   |
| Exposure value | Adjust the exposure value.   |
| Focus mode     | Take close-up photos or set the camera to focus on the subject.  |
| Timer          | Select the length of the delay before the camera takes a photo.  |
| Effects        | Apply a special effect, such as sepia or black and white tones.  |
| Resolution     | Change the resolution option.  |
| White balance  | Adjust the colour balance according to lighting conditions.  |
| ISO            | Adjust the sensitivity of the camera imaging sensor.   |

| Option          | Function  |
|-----------------|---|
| Metering        | Select a type of exposure metre.  |
| Blink detection | Set the camera to alert you when people close their eyes.   |
| Guidelines      | Display the gridlines on the preview screen.  |
| Image quality   | Set the quality level for your photos.  |
| GPS tag         | <p>Set the camera to include location information for your photos.</p>  <ul style="list-style-type: none"> <li>• To improve GPS signals, avoid shooting in locations where the signal may be obstructed, such as between buildings or in low-lying areas, or in poor weather conditions.</li> <li>• Your location may appear on your photos when you upload them to the web. To avoid this, deactivate the GPS tag setting.</li> </ul> |
| Storage         | Select a memory location for storing captured photos.   |
| Reset           | Reset menus and shooting options.   |

## Record a video

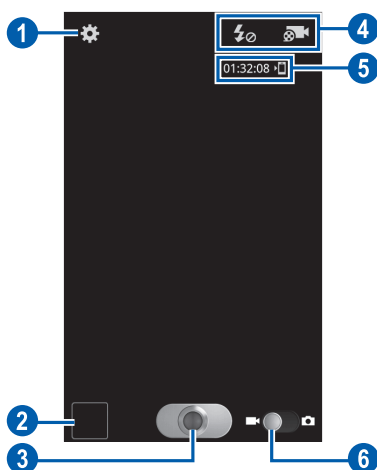
- 1 In Idle mode, open the application list and select **Camera** to turn on the camera.
- 2 Drag the slider to the camcorder to switch to the camcorder.
- 3 Aim the lens at the subject and make any necessary adjustments.



| Number | Function  |
|--------|---|
| 1      | Change the camcorder settings.  |
| 2      | Open the image viewer to view videos you recorded.  |
| 3      | Record a video.   |
| 4      | Use camcorder shortcuts. <ul style="list-style-type: none"><li>•  : Change the flash setting.</li><li>•  : Change the recording mode. You can add or remove shortcuts to frequently used options. ► p. 72</li></ul> |

| Number | Function   |
|--------|--|
| 5      | Check the camcorder status. <ul style="list-style-type: none"> <li>• <b>01:32:08</b> : Length of video that can be recorded (according to available memory)</li> <li>•  : Default storage location</li> </ul> |
| 6      | Switch to the camera.  |

4 Select  to start recording.

5 Select  to stop recording.

The video is saved automatically.



The camcorder may not be able to properly record videos to a memory card with a slow transfer speed.

After recording videos, select the image viewer icon to view the recorded videos.

- To view more videos, scroll left or right.
- To play a video, select .
- To send a video to others, select **Share**.
- To delete a video, select **Delete**.
- To use additional features with a video, select **More** and use the following options:
  - **Play**: Play a video.
  - **Rename**: Rename a video file.

## › Customise camcorder settings

Before recording a video, select  to access the following options:

| Option         | Function   |
|----------------|--|
| Edit shortcuts | Add or remove shortcuts to frequently used options.                        |
| Flash          | Change the flash setting; You can manually turn the flash on or off.       |
| Recording mode | Change the recording mode.   |
| Exposure value | Adjust the exposure value.   |
| Timer          | Select the length of the delay before the camera starts recording a video. |
| Effects        | Apply a special effect, such as sepia or black and white tones.            |
| Resolution     | Change the resolution option.  |
| White balance  | Adjust the colour balance according to lighting conditions.                |
| Video quality  | Set the quality level for your videos.                                     |
| Guidelines     | Display the gridlines on the preview screen.                               |
| Storage        | Select a memory location for storing recorded videos.                      |
| Reset          | Reset menus and recording options.   |

## › Edit the shortcut icons

You can add or remove shortcuts to frequently used options.

- 1 From the preview screen, select  → **Edit shortcuts** or press [≡] → **Edit shortcuts**.
- 2 Tap and hold an icon from the option list and drag it to the shortcut area.  
To remove shortcuts, tap and hold an icon and drag it to the option list.
- 3 Press [↶] to return to the preview screen.







## Video player

Learn to use the video player to play various kinds of videos. The video player supports the following file formats: 3gp, mp4, avi, wmv, flv, mkv.

-  • Avoid locking the device's screen while playing a DivX Video-On-Demand. Each time you lock the screen while playing a DivX Video-On-Demand, one of your available rental counts will be decremented.
  - Some file formats are not supported depending on the software of the device.
  - If the file size exceeds the available memory, an error can occur when you open files.
  - Playback quality may vary by content type.
  - Some files may not play properly depending on how they are encoded.
- 1 In Idle mode, open the application list and select **Video player**.
  - 2 Select a video to play.
  - 3 Rotate the device to landscape view.



#### 4 Control playback with the following icons:

| Icon  | Function   |
|---|--|
|  | Change a ratio of the video screen.  |
|  | Restart playback; Skip backward (tap within 2 seconds); Scan backward in a file (tap and hold).                              |
|  | Pause playback; Select  to resume playback. |
|  | Skip forward; Scan forward in a file (tap and hold).   |
|  | Activate the 5.1 channel surround sound system when a headset is connected.  |
|  | Adjust the volume.   |

## Gallery

Learn to view photos and play videos saved in your device's memory and memory card.



### › Supported file formats

| Type  | Format                       |
|-------|------------------------------|
| Image | bmp, gif, jpg, png           |
| Video | 3gp, mp4, avi, wmv, flv, mkv |





- Avoid locking the device's screen while playing a DivX Video-On-Demand. Each time you lock the screen while playing a DivX Video-On-Demand, one of your available rental counts will be decremented.
- Some file formats are not supported depending on the software of the device.
- If the file size exceeds the available memory, an error can occur when you open files.
- Playback quality may vary by content type.
- Some files may not play properly depending on how they are encoded.

## › View a photo

- 1 In Idle mode, open the application list and select **Gallery**.
- 2 Select a folder.
- 3 To change the view mode, select  or  at the top right of the screen.
- 4 Select a photo (with no icon) to view.

While viewing a photo, use the following options:

- To view more photos, scroll left or right.
- To zoom in, place two fingers on the screen and spread them apart. To zoom out, move your fingers closer together. You can also select  or , or double-tap the screen.



If you activated tilting motions, you can zoom in or out by tapping and holding two points with your fingers and then tilting the device back and forth.

- To send a photo to others, select **Send via**.
- To delete a photo, select **Delete** → **Confirm deletions**.













- To share a photo with others via AllShare or community websites, press [≡] → **Share**.
- To set a photo as wallpaper or a caller ID image for a contact, press [≡] → **Set as**.
- To use additional features with a photo, press [≡] → **More** and use the following options:
  - **Copy:** Copy a photo file.
  - **Print:** Print a photo using a Wi-Fi or USB connection. Your device is compatible only with some Samsung printers.
  - **Edit:** Edit a photo.
  - **Crop:** Crop an image from a photo.
  - **Motion:** Access the settings to control motion recognition of your device.
  - **Rotate left:** Rotate a photo anti-clockwise.
  - **Rotate right:** Rotate a photo clockwise.
  - **Slideshow:** Start a slideshow in the selected folder.
  - **Rename:** Rename a photo file.
  - **Details:** View photo details.

## ▶ Play a video

- 1 In Idle mode, open the application list and select **Gallery**.
- 2 Select a video (with the  icon) to play.
- 3 Rotate the device to landscape view.
- 4 Control playback with the virtual keys. ▶ p. 72

## Photo editor

You can edit photos and apply various effects.

- 1 In Idle mode, open the application list and select **Photo editor**.
- 2 Select **Select picture** → a folder → an image.  
To take a new photo, select **Capture picture**.
- 3 Select  → **New selection** → **OK**.
  - To add to or subtract from the selection border, select  → **Add to selection** or **Remove from selection**.
  - To reverse the selection, select  → **Inverse selection**.
  - To change the selection size, select .
  - To rotate or flip the image, select .
  - To crop the image, select .
  - To undo or redo your last action, select  or .
- 4 Drag your finger over the area you want to select.
- 5 Select  to apply a colour effect, or select  to apply a filter effect.  
To use additional tools, such as copying and warping, select .
- 6 Adjust the image as desired (if necessary) and select **Done**.
- 7 When you are finished, press [] → **Save**.
- 8 Enter a name and select **OK**.

## Music player

Learn to listen to your favourite music while on the go with the music player. The music player supports the following file formats: mp3, m4a, mp4, 3gp, 3ga, wma, ogg, oga, aac, flac.



- Some file formats are not supported depending on the software of the device.
- If the file size exceeds the available memory, an error can occur when you open files.
- Playback quality may vary by content type.
- Some files may not play properly depending on how they are encoded.

### › Add music files to your device









Start by transferring files to your device or memory card:

- Download from the wireless web. ▶ p. 93
- Download from a PC with Samsung Kies. ▶ p. 116
- Receive via Bluetooth. ▶ p. 107
- Copy to your memory card. ▶ p. 116

## › Play music

After transferring music files to your device or memory card,

- 1 In Idle mode, open the application list and select **Music player**.
- 2 Select a music category → a music file.
- 3 Control playback with the following icons:

| Icon  | Function   |
|---|--|
|    | Adjust the volume.   |
|    | Activate the 5.1 channel surround sound system when a headset is connected.  |
|    | Activate Shuffle mode.   |
|    | Change the repeat mode (off, repeating a file, or repeating all files).  |
|    | Restart playback; Skip backward (tap within 2 seconds); Scan backward in a file (tap and hold).                              |
|    | Pause playback; Select  to resume playback. |
|  | Skip forward; Scan forward in a file (tap and hold).   |



You can control the music player with a headset. In Idle mode, press and hold the headset button to launch the music player. Press the headset button to start or pause playback.

## › Create a playlist

- 1 In Idle mode, open the application list and select **Music player**.
- 2 Select **Playlists**.
- 3 Press [≡] → **Create**.
- 4 Enter a title for your new playlist and select **Save**.
- 5 Select **Add music**.
- 6 Select the files you want to include and select **Add**.

During playback, you can add files to a playlist by pressing [≡] → **Add to playlist** → a playlist.

## › Add songs to the quick list

You can add songs to the quick list and save them as a playlist. During playback, press [≡] → **Add to quick list** to add the current song to the quick list.

To go to the quick list, from the music player main screen, select **Playlists** → **Quick list**. To save the quick list as a playlist, press [≡] → **Save as playlist**.

## › Customise music player settings

- 1 In Idle mode, open the application list and select **Music player**.
- 2 Press [≡] → **Settings**.
- 3 Adjust the following settings to customise your music player:

| Option       | Function                         |
|--------------|----------------------------------|
| Equaliser    | Select a default equaliser type. |
| Sound effect | Select a sound effect.           |

| Option         | Function  |
|----------------|---|
| Music menu     | Select music categories to display on the music library screen.                               |
| Visualisation  | Display an animated visualisation during playback.  |
| Lyrics         | Set to display lyrics during playback. The music player supports lyrics with ID3v2 tags only. |
| Music auto off | Set the music player to automatically turn off after a specified length of time.              |

## Music Hub

You can access the online music store, and search for and buy your favourite songs. You can also add a music file to your wish list and play downloaded music files.



This feature may be unavailable depending on your region or service provider.

- 1 In Idle mode, open the application list and select **Music Hub**.
- 2 If you are launching this application for the first time, select **Confirm**.
- 3 Search for songs, and preview or buy your favourite songs.

## FM radio

Learn to listen to music and news on the FM radio. To listen to the FM radio, you must connect a headset, which serves as the radio antenna.



## › Listen to the FM radio

- 1 Plug a headset into the device.
- 2 In Idle mode, open the application list and select **FM radio**.

The FM radio scans and saves available stations automatically.

-  The first time you turn on the FM radio, it will start automatic tuning.

- 3 Control the FM radio with the following keys:





| Number | Function  |
|--------|---|
| 1      | Turn off or on the FM radio.                          |
| 2      | Search for an available radio station.                |
| 3      | Add the current radio station to the favourites list. |
| 4      | Adjust the volume.                                    |
| 5      | Fine-tune the frequency.                              |

## › Save a radio station automatically

- 1 Plug a headset into the device.
- 2 In Idle mode, open the application list and select **FM radio**.
- 3 Press [≡] → **Scan** → a scanning option.  
The FM radio scans and saves available stations automatically.

## › Add a radio station to the favourites list

- 1 Plug a headset into the device.
- 2 In Idle mode, open the application list and select **FM radio**.
- 3 Select  to turn on the FM radio.
- 4 Scroll to the radio station you want.
- 5 Select  to add to the favourites list.

 You can add a name for a radio station or remove a radio station; Tap and hold a radio station on the favourites list and select **Remove** or **Rename**.

## › Customise FM radio settings

- 1 In Idle mode, open the application list and select **FM radio**.
- 2 Press [≡] → **Settings**.

### 3 Adjust the following settings to customise your FM radio:

| Option                | Function   |
|-----------------------|--|
| Background playing    | Set whether or not to run the FM radio in the background while using other applications. If this feature is on, you can control the FM radio from the notifications panel. |
| Show station ID       | Set whether or not to show the station ID on the FM radio screen; Station IDs are available only from radio stations that provide this information.                        |
| Alternative frequency | Set whether or not the FM radio attempts to retune a radio station when the signal is weak.  |
| FM auto off           | Set the FM radio to automatically turn off after a specified length of time.   |

## Game Hub

Learn to play social and premium games.

- 1 In Idle mode, open the application list and select **Game Hub**.
- 2 If you are launching this application for the first time, select **Confirm**.
- 3 Select and install a game.
- 4 Follow the on-screen instructions.



- Available games may vary depending on your region or service provider.
- Controls and options of games may vary.

# Personal information

## Contacts

Learn to create and manage a list of your personal or business contacts. You can save names, mobile phone numbers, home phone numbers, email addresses, birthdays and more for your contacts.

### › Create a contact

- 1 In Idle mode, open the application list and select **Contacts**.
- 2 Select .
- 3 Select a memory location.  
If you have more than one account, select an account to which you want to add the contact.
- 4 Enter contact information.
- 5 Select **Save** to add the contact to memory.





You can also create a contact from the dialling screen.

- 1 In Idle mode, open the application list and select **Phone** → **Keypad**.
- 2 Enter a phone number.
- 3 Select **Add to Contacts** → **Create contact**.
- 4 Select a memory location.  
If you have more than one account, select an account to which you want to add the contact.
- 5 Enter contact information.
- 6 Select **Save** to add the contact to memory.

## › Find a contact

- 1 In Idle mode, open the application list and select **Contacts**.
- 2 Scroll up or down on the contact list.  
You can also drag your finger along the index on the right side to quickly scroll through the list.
- 3 Select a contact's name.

Once you find a contact, you can use the following options:

- To call the contact, select  or .
- To send a message, select .
- To send an email message, select .
- To edit the contact information, press [≡] → **Edit**.
- To set the contact as your favourites, select .

## › Set a speed dial number

- 1 In Idle mode, open the application list and select **Contacts**.
- 2 Press [≡] → **Speed dial settings**.
- 3 Select a location number → a contact.
- 4 Select a phone number (if necessary).

 You can quickly dial this number by tapping and holding the location number from the dialling screen.

## › Create your namecard

- 1 In Idle mode, open the application list and select **Contacts**.
- 2 Press [≡] → **My profile**.
- 3 Press [≡] → **Edit**.

4 Enter your own personal details.

5 Select **Save**.



You can send your namecard by attaching it to a message or email or transferring it via the Bluetooth wireless feature.

## › Retrieve contacts from your community accounts

You can view the list of community website accounts and select an account to add a contact from the website to your phone contacts.

1 In Idle mode, open the application list and select **Contacts**.

2 Press [≡] → **More** → **View SNS friends**.

3 Select an account.

4 Follow the on-screen instructions.

## › Create a group of contacts

By creating groups of contacts, you can manage multiple contacts and send messages or email to an entire group. Start by creating a group.

1 In Idle mode, open the application list and select **Contacts**.

2 Scroll left or right to **Groups**.

3 Press [≡] → **Create**.

4 Enter a name and select a ringtone for the group.

5 Select **Add member**, select contacts to add to the group, and select **Add**.

6 Select **Save**.

## › Copy contacts

To copy contacts from the SIM or USIM card to your device,

- 1 In Idle mode, open the application list and select **Contacts**.
- 2 Press [≡] → **More** → **Import/Export** → **Import from SIM card**.
- 3 Select a memory location.  
If you have more than one account, select an account to which you want to add the contact.
- 4 Select contacts to copy and select **Import**.

To copy contacts from your device to the SIM or USIM card,

- 1 In Idle mode, open the application list and select **Contacts**.
- 2 Press [≡] → **More** → **Import/Export** → **Export to SIM card**.
- 3 Select contacts to copy and select **Export** → **Yes**.

## › Import or export contacts

To import contact files (in vcf format) from a memory card to your device,

- 1 In Idle mode, open the application list and select **Contacts**.
- 2 Press [≡] → **More** → **Import/Export** → **Import from SD card**.
- 3 Select a memory location.  
If you have more than one account, select an account to which you want to add the contact.

- 4 Select an option for importing a single contact file, multiple contact files, or all contact files, and select **OK**.
- 5 Select contact files to import and select **OK**.

To export contacts from your device to a memory card,

- 1 In Idle mode, open the application list and select **Contacts**.
- 2 Press [≡] → **More** → **Import/Export** → **Export to SD card**.
- 3 Select **OK** to confirm.

## Calendar

Learn to create and manage daily, weekly, or monthly events, and set alarms to remind yourself of important events.

### › Create an event

- 1 In Idle mode, open the application list and select **Calendar**.
- 2 Select **Tap to create event** or press [≡] → **Create**.
- 3 If alert messages about the calendar sync appear, select **OK**.
- 4 Enter the details of the event as required.
- 5 Select **Save**.



## › View events

To change the calendar view,

- 1 In Idle mode, open the application list and select **Calendar**.
- 2 Select a view mode from the top of the calendar.

To view events of a specific date,

- 1 In Idle mode, open the application list and select **Calendar**.
- 2 Select a date on the calendar. In month view, days with scheduled events are indicated by a small square.
  - To move to a specific day by entering a date manually, press [F≡] → **Go to**, enter the date by selecting + or -, and select **Set**.
  - To select today's date, press [F≡] → **Today**.
- 3 Select an event to view its details.



You can send the event to others by pressing [F≡] → **Send via** → an option.

## › Stop an event alarm

If you set an alarm for a calendar event, the event alarm icon will appear at the specified time.

- 1 Open the notifications panel from the top of the screen.
- 2 Select a reminder to view more details about the event.
- 3 To snooze or dismiss the reminder, select the check box next to the event and select **Snooze** or **Dismiss**.

## Task

Learn to create a task list and set alarms to remind yourself of important tasks or set priority.

### › Create a task

- 1 In Idle mode, open the application list and select **Task**.
- 2 Select **Create task** to create a task.
- 3 Enter the details of the task.
- 4 Select **Save**.

### › View a task

- 1 In Idle mode, open the application list and select **Task**.
- 2 Press [≡] → **List by** → an option to sort the tasks.
- 3 Select a task to view its details.  
For completed tasks with an expired deadline, you can set their status to completed by selecting the check box.



## Memo





Learn to record important information to save and view at a later date.

### › Create a memo

- 1 In Idle mode, open the application list and select **Memo**.
- 2 If there is a memo saved, select **Create memo** to create a memo.
- 3 Enter your memo text and select **Save**.

## › View memos

- 1 In Idle mode, open the application list and select **Memo**.
- 2 Press [F≡] → **Search** or press and hold [F≡] to search for a memo (if necessary).
- 3 Select a memo to view its details.
  - To edit the memo, select .
  - To use additional features with a memo, select .

| Option  | Function   |
|---|--|
|  | Delete the memo.   |
|  | Change the background colour of the memo.  |
|  | Lock the memo.   |
|  | Print the memo using a Wi-Fi or USB connection. Your device is compatible only with some Samsung printers. |

 You can send the memo to others by pressing [F≡] → **Send** → an option.

## Voice recorder

Learn to operate your device's voice recorder.

### › Record a voice memo

- 1 In Idle mode, open the application list and select **Voice recorder**.
- 2 Select **Record** to start recording.
- 3 Speak into the microphone.
- 4 When you are finished, select **Stop**.  
Your memo is saved automatically.
- 5 To record more voice memos, select **Record** again.

### › Play a voice memo

- 1 In Idle mode, open the application list and select **Voice recorder**.
- 2 Select **List**.
- 3 Select a voice memo to play.



You can send the voice memo to others by pressing [≡] → **Share** → an option.

# Web

Web services require a data connection. Contact your operator to choose the best data plan.

## Internet

Learn to access and bookmark your favourite web pages.



- You may incur additional charges for accessing the web and downloading media files. For details, contact your service provider.
- Available icons may vary depending on your region or service provider.

### › Browse web pages

1 In Idle mode, open the application list and select **Internet** to launch a specified homepage.

To access a specific web page, select the URL input field, enter the web address (URL) of the web page, and select →.

2 Navigate web pages with the following keys:



| Number | Function   |
|--------|--|
| 1      | Enter the web address of a web page to access.   |
| 2      | Open a list of saved bookmarks, frequently visited pages, and recent internet history. |

While browsing the web page, use the following options:

- To zoom in, place two fingers on the screen and spread them apart. To zoom out, move your fingers closer together. You can also double-tap the screen.



If you activated tilting motions, you can zoom in or out by tapping and holding two points with your fingers and then tilting the device back and forth.

- To open a new window, press [≡] → **New window**.
- To view the currently active windows, press [≡] → **Windows**. You can open multiple pages and switch back and forth between them.
- To adjust the brightness of the screen, press [≡] → **Browser brightness**. This feature may be unavailable depending on your region.
- To reload the current web page, press [≡] → **Refresh**.
- To go to a next page in history, press [≡] → **Forward**.
- To bookmark the current web page, press [≡] → **More** → **Add bookmark**.
- To add a shortcut to the current web page to the idle screen, press [≡] → **More** → **Add shortcut to home**.
- To search for text on the web page, press [≡] → **More** → **Find on page**.
- To view the web page details, press [≡] → **More** → **Page info**.
- To send the web address (URL) of the web page to others, press [≡] → **More** → **Share page**.
- To view the download history, press [≡] → **More** → **Downloads**.

- To customise the browser settings, press [≡] → **More** → **Settings**.
- To print the current web page using a Wi-Fi or USB connection, press [≡] → **More** → **Print**. Your device is compatible only with some Samsung printers.

## › Search for information by voice



This feature may be unavailable depending on your region or service provider.

- 1 In Idle mode, open the application list and select **Internet**.
- 2 Select the URL input field.
- 3 Select  and say a keyword into your device's microphone. The device searches for information and web pages related with the keyword.

## › Bookmark your favourite web pages

If you know the web address of the web page, you can manually add a bookmark. To add a bookmark,

- 1 In Idle mode, open the application list and select **Internet**.
- 2 Select  → **Bookmarks**.
- 3 Select **Add** or press [≡] → **Bookmark last-viewed page**. To bookmark the web page you were viewing, skip to step 5.
- 4 Enter a page title and a web address (URL).
- 5 Select **OK**.

From the bookmark list, tap and hold a bookmark and use the following options:

- To open the web page in the current window, select **Open**.
- To open the web page in a new window, select **Open in new window**.
- To edit the bookmark details, select **Edit bookmark**.
- To add the bookmark shortcut to the idle screen, select **Add shortcut to home**.
- To send the web address (URL) of the web page to others, select **Share link**.
- To copy the web address (URL) of the web page, select **Copy link URL**.
- To delete the bookmark, select **Delete bookmark**.
- To use the web page as your homepage of the browser, select **Set as homepage**.

## › Access the frequently visited pages or the recent history

- 1 In Idle mode, open the application list and select **Internet**.
- 2 Select  → **Most visited** or **History**.
- 3 Select a web page to access.



You can add a web page to the bookmark list by selecting .











# Maps

Learn to use Google Maps™ to find your location, search the online map for streets, cities, or countries, and get directions.







- This feature may be unavailable depending on your region or service provider.
- You must activate location services to find your location and search the map. ► p. 115

## › Search for a specific location

- 1 In Idle mode, open the application list and select **Maps**.
- 2 If you are launching this application for the first time, select **OK**.  
The map will display your current location.
- 3 Press [≡] → **Search**.
- 4 Enter a keyword for the location and select .  
To search for a location by voice, select .
- 5 Select the location you want to view details.
  - To view a list of all results for your search, select .
  - To zoom in or out, select  or .
  - To add layers to the map, select .
  - To view your current location, select . To switch to the compass view of the map that changes orientation when you move the device, select .
  - To add a star to the location, select the balloon with the location name → .

## › Get directions to a specific destination

- 1 In Idle mode, open the application list and select **Maps**.
- 2 Press [≡] → **Directions**.
- 3 Enter the addresses of the starting location and the ending location.  
To enter an address from your contact list or starred places, or point the location on the map, select  → **Contacts**, **Point on map**, or **My Places**.
- 4 Select a travel method (car, bus, or walk) and select **Get directions**.  
The route is indicated on the map. Depending on the selected travel method, you may see multiple routes. Select a route to view details of your trip and select  to view the route on the map.
- 5 Select  or  to view only the single part of the route.
- 6 When you are finished, press [≡] → **Clear Map**.

## Latitude

Learn to share your location with your friends and view friends' locations via Google Latitude™.

- 1 In Idle mode, open the application list and select **Latitude**.  
The device automatically joins Latitude.
- 2 Select  → **Select from Contacts** or **Add via email address**.
- 3 Select a friend you want to add, or enter an email address and select **Add friends**.

4 Select **Yes**.

When your friend accepts your invitation, you can share locations.

5 Press [≡] → **Map View**.

Your friends' locations are marked with their photos on the map.

## Places

Learn to search for a place around you.



This feature may be unavailable depending on your region or service provider.

1 In Idle mode, open the application list and select **Places**.

2 Select a category.

Your device searches for places around your current location that are related to the category.

3 Select a place name to view its details.

4 While viewing information, use the following options:

- To view the place on the map, select **Map**.
- To view the route to the place, select **Directions**.
- To view the phone number of the place, select **Call**.

# Navigation

Learn to use the GPS navigation system to find and show your destination with voice guidance.



- Navigation maps, your current location, and other navigational data may differ from actual location information. You should always pay attention to road conditions, traffic, and any other factors that may affect your driving and follow all safety warnings and regulations while driving.
- This feature may be unavailable depending on your region or service provider.

- 1 In Idle mode, open the application list and select **Navigation**.
- 2 If you are launching this application for the first time, select **Accept**.
- 3 Enter your destination by using one of the following methods:
  - **Speak Destination:** Speak your destination such as "Navigate to destination."
  - **Type Destination:** Enter your destination with the virtual keypad.
  - **Contacts:** Select your destination from addresses of your contacts.
  - **Starred Places:** Select your destination from the list of your starred places.
- 4 Follow the on-screen instructions to use the navigation service.

# YouTube

Learn to view and share videos via YouTube.



This feature may be unavailable depending on your region or service provider.



## › Watch videos



- 1 In Idle mode, open the application list and select **YouTube**.
- 2 Select a video from the list.
- 3 Rotate the device to landscape view.
- 4 Control playback with the icons on the screen.

## › Share videos

- 1 In Idle mode, open the application list and select **YouTube**.
- 2 Select a video.
- 3 Select  → an option.

## › Upload videos

- 1 In Idle mode, open the application list and select **YouTube**.
- 2 Press [] → **Upload** and select a video. Skip to 7. If you want to upload new videos, select  to turn on the camera.

- 3 Aim the lens at the subject and make any adjustments.
- 4 Select  to start recording.
- 5 Select  to stop recording.
- 6 Select **Save** to upload the video that you have recorded.
- 7 Select your Google account if it is linked to YouTube. You can also select **Add account** and set up an account to sign in YouTube.
- 8 Enter details of the upload and select **Upload**.

## Samsung Apps

Samsung Apps allows you to simply and easily download an abundance of applications directly to your device. Featuring a wealth of games, news, reference, social networking, navigation, health related applications and more, Samsung Apps gives you instant access to a huge choice of mobile experience.

Your device gets smarter with fully optimised applications from Samsung Apps. Explore amazing applications and make your mobile life even better.



- The feature may be unavailable depending on your region or service provider.
- For details, please visit [www.samsungapps.com](http://www.samsungapps.com).

- 1 In Idle mode, open the application list and select **Samsung Apps**.
- 2 If you are launching this application for the first time, select a region → **OK**. Then read the terms and conditions and select **Accept**.
- 3 Search for and download applications as desired.

## Play Shop (Play Store)

You can download games, ringtones, or other applications from Play Shop.



This feature may be unavailable depending on your region or service provider.

- 1 In Idle mode, open the application list and select **Play Shop (Play Store)**.
- 2 Search for a file and download it to the device. ► p. 41

## News & Weather

Learn to view the weather information and read top news and other news articles.

### › View the weather information

- 1 In Idle mode, open the application list and select **News & Weather**.
  - 2 Select **Weather** at the top of the screen.  
Your device searches for your current location and displays the weather information.
-  You can change the location to view the weather information in another region. Press [≡] → **Settings** → **Weather settings** and clear the check box next to **Use My Location**. Then select a location in **Set location**.

## › Read news articles

- 1 In Idle mode, open the application list and select **News & Weather**.
- 2 Scroll left to a news topic at the top of the screen.
- 3 Select an article to open it.



To add news topics, press [≡] → **Settings** → **News settings** → **Select news topics**.



# Connectivity

## Bluetooth

Bluetooth is a short-range wireless communications technology capable of exchanging information over a distance of about 10 m without requiring a physical connection.

You do not need to line up the devices to beam information with Bluetooth. If the devices are within range of one another, you can exchange information between them even if they are located in different rooms.



- Samsung is not responsible for the loss, interception, or misuse of data sent or received via the Bluetooth wireless feature.
- Always ensure that you share and receive data with devices that are trusted and properly secured. If there are obstacles between the devices, the operating distance may be reduced.
- Some devices, especially those that are not tested or approved by Bluetooth SIG, may be incompatible with your device.
- Do not use the Bluetooth feature for illegal purposes (for example, pirating copies of files or illegally tapping communications for commercial purposes). Samsung is not responsible for the repercussions of illegal use of the Bluetooth feature.

### › Turn on the Bluetooth wireless feature

*I* In Idle mode, open the application list and select **Settings**  
→ **Wireless and network** → **Bluetooth settings**.

- 2 Select **Bluetooth** to turn on the Bluetooth wireless feature.

## › Find and pair with other Bluetooth-enabled devices

- 1 In Idle mode, open the application list and select **Settings** → **Wireless and network** → **Bluetooth settings** → **Scan for devices**.

- 2 Select a device.

- 3 Enter a PIN for the Bluetooth wireless feature or the other device's Bluetooth PIN, if it has one, and select **OK**. Alternatively, select **Accept** to match the PIN between your device and the device.

When the owner of the other device enters the same PIN or accepts the connection, pairing is complete. If the pairing is successful, the device will automatically search for available services.

-  Some devices, especially headsets or hands-free car kits, may have a fixed Bluetooth PIN, such as 0000. If the other device has a PIN, you must enter it.

## › Send data using the Bluetooth wireless feature

- 1 Select a file or item, such as a contact, calendar event, memo, or media file, from an appropriate application or My files.

- 2 Select an option for sending data via Bluetooth.

-  The method for selecting an option may vary by data type.

- 3 Search for and pair with a Bluetooth-enabled device.

## › Receive data using the Bluetooth wireless feature

- 1 In Idle mode, open the application list and select **Settings** → **Wireless and network** → **Bluetooth settings** → **Visible**.

Your device is visible to other Bluetooth devices for a specified period.

You can set the duration that your device is visible to other Bluetooth devices by selecting **Visible time-out**.

- 2 When prompted, enter the PIN for the Bluetooth wireless feature and select **OK** (if necessary).
- 3 Select **Accept** to confirm that you are willing to receive data from the device.

Received data is saved to the bluetooth folder. If you receive a contact, it is automatically saved to the phonebook.

## Wi-Fi

Learn to use your device's wireless networking capabilities to activate and connect to any wireless local area network (WLAN) compatible with the IEEE 802.11 b/g/n standards.

You can connect to the internet or other network devices anywhere an access point or wireless hotspot is available.

-  Your device uses non-harmonised frequency and is intended for use in all European countries. The Wi-Fi can be operated in the EU without restriction indoors, but cannot be operated outdoors in France.

## › Activate the Wi-Fi feature

In Idle mode, open the application list and select **Settings** → **Wireless and network** → **Wi-Fi settings** → **Wi-Fi**.



The Wi-Fi feature running in the background will consume battery power. To preserve battery power, activate the feature only when needed.

## › Find and connect to a Wi-Fi AP

1 In Idle mode, open the application list and select **Settings** → **Wireless and network** → **Wi-Fi settings**.

The device will automatically search for available Wi-Fi APs.

2 Select a network under **Wi-Fi networks**.

3 Enter a password for the network (if necessary).

4 Select **Connect**.

## › Add a Wi-Fi AP manually

1 In Idle mode, open the application list and select **Settings** → **Wireless and network** → **Wi-Fi settings** → **Add Wi-Fi network**.

2 Enter the SSID for the network and select the security type.

3 Set the security settings depending on the selected security type.

4 Select **Save**.

## › Connect to a Wi-Fi AP using a Wi-Fi Protected Setup (WPS)

Using WPS, you can connect to a secured network.

To connect to a Wi-Fi AP with a WPS button,

- 1 In Idle mode, open the application list and select **Settings** → **Wireless and network** → **Wi-Fi settings**.
- 2 Select **WPS button connection**.
- 3 Press a WPS button on the access point within 2 minutes.

To connect to a Wi-Fi AP with a WPS PIN,

- 1 In Idle mode, open the application list and select **Settings** → **Wireless and network** → **Wi-Fi settings**.
- 2 Select a network indicated by the WPS icon and select **WPS PIN**.
- 3 On the access point, enter the PIN and press the start button.

## Wi-Fi Direct

Learn to use the Wi-Fi Direct feature to connect two devices via Wi-Fi without requiring an access point.

## › Connect your device to another device

- 1 In Idle mode, open the application list and select **Settings** → **Wireless and network** → **Wi-Fi Direct settings** → **OK** → **OK** → **Wi-Fi Direct**.

2 Press [≡] → **Scan**.

3 Select a device and then select **Connect**.

When the owner of the other device accepts the connection, the devices are connected.

## › Send data via Wi-Fi

1 Select a file or item, such as a memo, media file, or web address, from an appropriate application or My files.

2 Select an option for sending data via Wi-Fi.



The method for selecting an option may vary by data type.

3 Search for and select another device.

## › Receive data via Wi-Fi

When prompted, select **OK** to confirm that you are willing to receive data. Received data is saved to the ShareViaWifi folder.

## AllShare

Learn to use the Digital Living Network Alliance (DLNA) service that enables you to share media files between DLNA-enabled devices in your home over Wi-Fi.



- The supported file formats may vary depending on the software of the device.
- Some files may not play on the DLNA-enabled devices depending on the devices.

## › Customise DLNA settings for sharing media files

To allow other DLNA-enabled devices to access media files on your device, you must activate media sharing.

- 1 In Idle mode, open the application list and select **AllShare**.
- 2 Press [≡] → **Settings**.
- 3 Adjust the following settings to customise the DLNA feature:

| Option                    | Function  |
|---------------------------|---|
| Device name               | Enter a name for your device as a media server.                       |
| Share videos              | Turn on video sharing with other DLNA-enabled devices.                |
| Share photos              | Turn on image sharing with other DLNA-enabled devices.                |
| Share music               | Turn on music sharing with other DLNA-enabled devices.                |
| Upload from other devices | Set whether or not to accept the upload from other devices.           |
| Default memory            | Select the default memory location for saving downloaded media files. |
| Subtitles                 | Set to display subtitles.   |

## › Play your files on another DLNA-enabled device

- 1 In Idle mode, open the application list and select **AllShare**.
- 2 Select **My device**.
- 3 Select a media category and a file.
- 4 Select a player—the one that will play the media file. Playback begins at the selected player.
- 5 Control playback using icons of your device.

 Playback may be buffered, depending on the network connection and the connected server.

## › Play files from one device on the other device

- 1 In Idle mode, open the application list and select **AllShare**.
- 2 Select **Remote device**.  
Your device automatically searches for DLNA-enabled devices.
- 3 Select a device as the media server—the one that contains media files.
- 4 Select a media category and a file.
- 5 Select a player—the one that will play the media file. Playback begins at the selected player.
- 6 Control playback using icons of your device.



## Mobile network sharing

Learn to set your device as a wireless modem or wireless access point for PCs or other devices, and share your device's mobile network connection.

### › Share your device's mobile network via Wi-Fi

- 1 In Idle mode, open the application list and select **Settings** → **Wireless and network** → **Tethering and portable hotspot**.
- 2 Select **Portable Wi-Fi hotspot settings** → **OK**.
- 3 Select **Portable Wi-Fi hotspot** → **OK** to activate the Wi-Fi tethering feature.
- 4 Select **Configure portable Wi-Fi hotspot** to configure network settings to use your device as an access point:

| Option       | Function  |
|--------------|---|
| Network SSID | View and edit the device name that will be shown to external devices. |
| Security     | Select the security type.   |

- 5 When you are finished, select **Save**.
- 6 From another device, locate your device's name in the available connection list and connect to the network. Your device shares the mobile network connection with the other device.

## › Share your device's mobile network via USB

- 1 Using a USB cable, connect the multifunction jack on your device to a PC.
- 2 In Idle mode, open the application list and select **Settings** → **Wireless and network** → **Tethering and portable hotspot**.
- 3 Select **USB tethering** to activate the USB tethering feature.  
Your device shares the mobile network connection on your PC.  
To stop sharing the network connection, clear the check box next to **USB tethering**.

 The sharing method for the network connection may differ depending on the PC's operating system.

## GPS

Your device is equipped with a global positioning system (GPS) receiver. Learn to activate location services.

To receive better GPS signals, avoid using your device in the following conditions:

- between buildings, in tunnels or underground passages, or inside buildings
- in poor weather
- around high voltage or electromagnetic fields
- in a vehicle with sun protection film

 Do not touch or cover the antenna area with your hands or other objects while using the GPS functions.

 This feature may be unavailable depending on your region or service provider.

## › Activate location services

You must activate location services to receive location information and search the map.

- 1 In Idle mode, open the application list and select **Settings** → **Location and security**.
- 2 Adjust the following settings to activate location services:

| Option                | Function  |
|-----------------------|---|
| Use wireless networks | Set to use Wi-Fi and/or mobile networks for finding your location.  |
| Use GPS satellites    | Set to use the GPS satellite for finding your location.   |
| Use sensor aiding     | Use sensors to enhance pedestrian positioning when the GPS signal is obstructed. There may be variations between the sensor estimates and your actual location. |

## PC connections

Learn to connect your device to a PC with a USB cable in USB connection modes. By connecting the device to a PC, you can transfer data to and from your device directly and use the Samsung Kies program.

## › Connect with Samsung Kies

Ensure that Samsung Kies is installed on your PC. You can download the program from the Samsung website ([www.samsung.com/kies](http://www.samsung.com/kies)).



Samsung Kies will work on both Windows and Macintosh computers.

- 1 Using a USB cable, connect the multifunction jack on your device to a PC.
- 2 Double-click the Samsung Kies icon on your PC to launch Samsung Kies.
- 3 Transfer or synchronise mobile data, such as contacts, calendars, music, or photos, between Samsung Kies and your device.  
Refer to the Samsung Kies help for more information.

## › Connect as a mass storage device

You can connect your device to a PC as a removable disk and access the file directory. If you insert a memory card in the device, you can access the file directory of the memory card by using the device as a memory card reader.



The file directory of the memory card will appear as a removable disk, separate from the internal memory.

- 1 If you want to transfer files from or to a memory card, insert a memory card into the device.
- 2 In Idle mode, open the application list and select **Settings** → **Wireless and network** → **USB utilities** → **Connect storage to PC**.

- 3 Select **OK** to confirm (if necessary).
- 4 Using a USB cable, connect the multifunction jack on your device to a PC.
- 5 When connected, select **Connect USB storage**.
- 6 Select **OK** to confirm (if necessary).
- 7 Open the folder to view files.
- 8 Copy files from the PC to the memory card.
- 9 When you are finished, select **Disconnect storage from PC**.



To disconnect the device from the PC, click the USB device icon on the Windows task bar and click the option to safely remove the mass storage device. Then remove the USB cable from the PC. Otherwise, you may lose data stored on the memory card or damage the memory card.

## VPN connections

You can create virtual private networks (VPN) and connect to your private network securely through a public network, such as the internet.



Your device should already be configured with internet access. If you have trouble accessing the internet, you need to edit connections. If you are not sure about the connection information to enter, ask your service provider.

## › Set up VPN connections

- 1 In Idle mode, open the application list and select **Settings** → **Wireless and network** → **VPN settings** → **Add VPN**.
- 2 Select a VPN type.
- 3 Customise the connection information.



Available options may vary depending on the VPN type.

| Option                   | Function  |
|--------------------------|---|
| VPN name                 | Enter a name of the VPN server.   |
| Set VPN server           | Enter the IP address of the VPN server.   |
| Enable encryption        | Set to encrypt the VPN server.  |
| Set IPsec pre-shared key | Enter a pre-shared key.   |
| Enable L2TP secret       | Set to use the L2TP secret password.  |
| Set L2TP secret          | Enter the L2TP secret password.   |
| Set user certificate     | Select a user certificate that the VPN server uses to identify you. You can import certificates from the VPN server or download from the web. |

| Option             | Function  |
|--------------------|---|
| Set CA certificate | Select a certificate authority (CA) certificate that the VPN server uses to identify you. You can import certificates from the VPN server or download from the web. |
| DNS search domains | Enter the domain name server (DNS) address.   |

4 When you are finished, press [≡] → **Save**.

## ▶ Connect to a private network

- 1 In Idle mode, open the application list and select **Settings** → **Wireless and network** → **VPN settings**.
- 2 Select a private network.
- 3 Enter the user name and password and select **Connect**.

# Tools

## Clock



Learn to set and control alarms and world clocks. You can also use the stopwatch, count-down timer, and the desk clock.

### › Set a new alarm

- 1 In Idle mode, open the application list and select **Clock** → **Alarm**.
- 2 Select **Create alarm**.
- 3 Set alarm details.  
Select the check box next to **Smart alarm** to activate simulated nature sounds with the alarm screen prior to the main alarm.
- 4 When you are finished, select **Save**.

### › Stop an alarm

When the alarm sounds,

- To stop the alarm, select  and then drag your finger outside of the large circle.
- To repeat the alarm after a specified length of time, select  and then drag your finger outside of the large circle.

### › Delete an alarm

- 1 In Idle mode, open the application list and select **Clock** → **Alarm**.
- 2 Press [] → **Delete**.
- 3 Select alarms to delete.
- 4 Select **Delete**.



## › Create a world clock

- 1 In Idle mode, open the application list and select **Clock** → **World clock**.
- 2 Select **Add city** or press [≡] → **Add**.
- 3 Enter a city name or select one from the city list.  
To select a city in the world map view, select .
- 4 To add more world clocks, repeat steps 2-3.



To apply the summer time to the clocks, tap and hold a clock and select **DST settings**.

## › Use the stopwatch

- 1 In Idle mode, open the application list and select **Clock** → **Stopwatch**.
- 2 Select **Start** to begin the stopwatch.
- 3 Select **Lap** to record lap times.
- 4 When you are finished, select **Stop**.
- 5 Select **Reset** to clear recorded times.

## › Use the count-down timer

- 1 In Idle mode, open the application list and select **Clock** → **Timer**.
- 2 Set the length of time to count down.
- 3 Select **Start** to begin the countdown.
- 4 When the timer expires, select  and then drag your finger outside of the large circle.

## › Use the desk clock

The desk clock displays the current time and date, and weather.

- 1 In Idle mode, open the application list and select **Clock** → **Desk clock**.
- 2 Select  to set an idle clock.
- 3 Press [≡] → **Settings**.
- 4 Change the following options:

| Option                | Function   |
|-----------------------|--|
| Hide status bar       | Set whether to show the status bar at the top of the screen.   |
| Wallpaper             | Select a background image for the idle clock.  |
| Time/Calendar display | Set to display the clock or calendar.  |
| AccuWeather           | Set to display the weather for your current location. You can also set the desk clock to be automatically updated with latest information and select a temperature unit. |
| Brightness            | Set the brightness of the display.   |
| Reset to default      | Reset the desk clock settings to the factory default values.   |

## Calculator

Learn to perform mathematical calculations directly on your device like a typical hand-held or desktop calculator.

## › Perform the calculation

- 1 In Idle mode, open the application list and select **Calculator**.
  - 2 Use the keys that correspond to the calculator display to perform basic mathematical operations.
-  Rotate the device to landscape view to use the scientific calculator. If you deactivate the auto rotation, press [≡] → **Scientific calculator**.

## › View the calculation history

- 1 In Idle mode, open the application list and select **Calculator**.
- 2 Perform the calculation.
- 3 Select  to close the calculator keypad.  
The calculation history appears.
- 4 To clear the history, press [≡] → **Clear history**.

## Downloads

Learn to manage logs of files you have downloaded from the web.

- 1 In Idle mode, open the application list and select **Downloads**.
- 2 Select a download folder.
- 3 To open a downloaded file, select the log.  
To delete a log, select the check box and then select **Delete**.

## Mini diary

Learn to keep a photo diary.

### › Create a Mini diary

- 1 In Idle mode, open the application list and select **Mini diary**.
- 2 If you are launching this application for the first time, select **Yes**.
- 3 If there is a diary saved, select **Create diary** to create a new entry.
- 4 Change the today's date and set the weather (if necessary).
- 5 Select **Tap to add photo** and add an image or capture a photo.  
To add a short description of the attached photo, select **Add location**.
- 6 Select **Tap to add text**, and enter text and select **Done**.
- 7 Select **Save**.

### › View a Mini diary

- 1 In Idle mode, open the application list and select **Mini diary**.
- 2 Select a diary.



- To upload a mini diary to your community website, press [≡] → **More** → **Publish**.
- To send a mini diary to others, press [≡] → **More** → **Send via**.

## My files

Learn to quickly and easily access all of your images, videos, music, sound clips, and other types of files stored in your device and memory card.

- 1 In Idle mode, open the application list and select **My files**.
- 2 Select a folder.
  - To move up one level in the file directory, select **Up**.
  - To return to the Home directory, select **Home**.
- 3 Select a file to open.

In a folder, press [≡] to use the following options:



- To send a file to others, select **Share**.
- To create a new folder, select **Create folder**.
- To delete files or folders, select **Delete**.
- To change the view mode, select **View by**.
- To sort files or folders, select **List by**.
- To use additional features using a file, such as moving, copying or renaming option, select **More**.

## Polaris Office









Learn to create and view Polaris Office documents on your device and memory card.

### › Create a document

- 1 In Idle mode, open the application list and select **Polaris Office**.
- 2 If you are launching this application for the first time, register as an online user or skip the registration.

- 3 Select  → a document type.
- 4 Create the document.
- 5 When you are finished, press [] → **Save**.
- 6 Enter a name for the document and select the saving location.
- 7 Select **Save**.

## › Open a document

- 1 In Idle mode, open the application list and select **Polaris Office**.
- 2 Select a folder under **My files** or **Recent documents** → a document file.
- 3 View the document as desired.
  - To zoom in, place two fingers on the screen and spread them apart. To zoom out, move your fingers closer together. You can also press [] → **Zoom** → an option.
  - To open the toolbar to edit the document (word, presentation, or excel file), press [] → **Edit mode**.
  - To search for text on the document, press [] → **Find**.
  - To bookmark the current page, press [] → **Bookclip**.
  - To adjust the document to fit the screen, press [] → **Reflow text**.
  - To move to a specific page, press [] → **More** → **Go to**.
  - To send a file to others, press [] → **More** → **Send file**.
  - To print the file using a Wi-Fi or USB connection, press [] → **More** → **Print**. Your device is compatible only with some Samsung printers.

- To read the document via the text-to-speech feature, press [≡] → **More** → **Text to speech**.
- To customise the settings for displaying or managing documents, press [≡] → **More** → **Settings**.



Available options may vary depending on a document type, or in landscape view and portrait view.

## › Manage documents online

- 1 In Idle mode, open the application list and select **Polaris Office**.
- 2 Select **Web files** → a service.
- 3 Enter your email address and password to access your account, and then select **Add**.
- 4 View and manage your documents on the server as desired.

## Projector

Learn to use the projector embedded in your device to project your device's display onto large surfaces.



Do not point the projector lens at people's eyes.



- Using the projector for extended periods will drain the battery quickly. Fully charge the battery before using the projector.
- Use the projector in a dark place. Projected images may not be visible in bright surroundings.
- Adjust the focus if images are blurred.
- The farther the device is placed from the screen, the more likely images are to be blurred.

## › Distance and screen size

The screen size in landscape view is based on the projector's distance from the projection surface.

| Distance (cm) | Screen size (cm) |
|---------------|------------------|
| 38.1          | 22.15 x 12.46    |
| 57.2          | 33.26 x 18.71    |
| 76.0          | 44.19 x 24.85    |
| 114.3         | 66.45 x 37.38    |
| 152.2         | 88.49 x 49.77    |
| 190.4         | 110.7 x 62.27    |



In portrait view, the screen size is reduced.

## › Project a file saved in your device

- 1 Open a file and press and hold [📷] to turn on the projector.
- 2 Adjust the projection distance and place the device on a flat surface.



For best results, project onto a flat screen at a 90° angle to the floor.

- 3 Adjust the projector view:
  - To adjust the focus, press [📷] and then press the Volume key up or down or drag the slider under **Adjust focus**.
  - To rotate the image, press [📷] and then select the icon under **Rotate**.



- 4 To use the following tools while projecting images or files, press [⊞] and then select the icon under **Quick pad**.

| Tool    | Function   |
|---------|--|
| Pointer | Point to a part of the screen.   |
| Pen     | Write or draw on the screen.   |
| Eraser  | Erase pen marks.   |
| Type    | Change the pointer type.   |
| Colour  | Change the pen colour. This option is available only when you select the pen.              |
| Thick   | Change the pen or eraser thickness. This option is available only when you select the pen. |
| Clear   | Clear your input.  |
| Exit    | Close the quick pad.   |

- 5 Press and hold [⊞] to turn off the projector.

## ► Project an image via the camera

- 1 In Idle mode, open the application list and select **Projector** → **Visual presenter**.
- 2 Adjust the projection distance and place the device on a flat surface.
- 3 Align the subject with the camera lens.

## ► Use Ambience mode

- 1 In Idle mode, open the application list and select **Projector** → **Ambience mode**.
- 2 Set the display and sound settings.
- 3 Select **Start**.

## › Activate the torch light

Learn to use the projector as a torch light in a dark place.

- 1 In Idle mode, open the application list and select **Projector** → **Torch light**.
- 2 Use the following options:
  - To adjust the brightness of the light, press the Volume key up or down. Alternatively, drag the slider.
  - To change the colour of the light, select **Colour**.
  - To make the light blink, select **Blinking speed**.

## › View alarms with the projector

When an alarm sounds, the projector will display the images or videos with sound.

- 1 In Idle mode, open the application list and select **Projector** → **Briefing**.
- 2 Select the check box next to **Briefing** to turn on the alarm.
- 3 Set alarm details.
- 4 Select **Save**.

## › Customise the projector settings

- 1 In Idle mode, open the application list and select **Projector** → **Settings**.
- 2 Adjust the following settings:

| Option               | Function                                |
|----------------------|---|
| Projector Brightness | Adjust the brightness of the projector. |

| Option             | Function   |
|--------------------|--|
| Screen timeout     | Set the length of time the device waits before turning off the display's backlight.                                |
| Screen orientation | Set the projector to rotate images automatically as you move your device or to show images only in landscape view. |

## Search

You can search for applications and data saved in your device and specific data on the web.

- 1 In Idle mode, open the application list and select **Search**.
- 2 If you are launching this application for the first time, set whether or not to view the search history of your Google account.
- 3 Enter a letter or a word of the data to search for.  
To search for data by voice, select  and say a keyword into your device's microphone
- 4 Select the item's name you want to access.

## SIM Toolkit

Use a variety of additional services offered by your service provider. Depending on your SIM or USIM card, this menu may be available but labelled differently. In Idle mode, open the application list and select **SIM Toolkit**.

# Task manager

With the task manager, you can view currently running applications and memory information.

- 1 In Idle mode, open the application list and select **Task manager**.
- 2 Use the following options:
  - **Active applications:** View the list of all the applications currently running on your device.
  - **Downloaded:** View the total amount of memory used for applications installed on your device.
  - **RAM:** Check and manage the RAM for your device.
  - **Storage:** View the used and available memory on your device and memory card.
  - **Help:** View help information about extending battery life and RAM manager.

# Voice command

Your device provides the intelligent voice command feature which turns your voice commands into action. You can dial a number, send a message, search for locations or information, or complete other tasks simply by speaking to your device.

- 1 In Idle mode, open the application list and select **Voice command**.
- 2 If you are launching this application for the first time, read the disclaimer and help information by following the screens.
- 3 Select **Tap & Speak**.
- 4 Say a command into the microphone.

## Voice Search

Learn to use the voice command feature to dial a number, send a message, or search for locations and information by voice.



This feature may be unavailable depending on your region or service provider.

- 1 In Idle mode, open the application list and select **Voice Search**.
- 2 Select **Speak now** (if necessary).
- 3 Say a command into the microphone.
- 4 Select an item's name.

## Voice talk

Learn to use the voice command feature provided by Voice talk. You can dial a number, send a message, write a memo, or complete other tasks simply by speaking to your device while on the go.

- 1 In Idle mode, open the application list and select **Voice talk**.
- 2 If you are launching this application for the first time, complete the tutorial.
- 3 Select **Tap & Speak**.
- 4 Say a command into the microphone.
- 5 Select an item's name.

# Settings

## Access the Settings menu

- 1 In Idle mode, open the application list and select **Settings**.
- 2 Select a setting category and select an option.

## Wireless and network

Change the settings for wireless network connections.

### › Flight mode

Disable all wireless functions on your device. You can use only non-network services.

### › Wi-Fi settings

- **Wi-Fi:** Turn the Wi-Fi feature on or off. ► p. 108
- **Network notification:** Set the device to notify you when an open network is available.
- **WPS button connection:** Connect to a Wi-Fi AP using a Wi-Fi Protected Setup (WPS) button.
- **Add Wi-Fi network:** Add Wi-Fi APs manually.

### › Wi-Fi Direct settings

- **Wi-Fi Direct:** Activate the Wi-Fi Direct feature to connect two devices via Wi-Fi without requiring an access point.  
► p. 109
- **Device name:** View or edit the name for your device.
- **Status:** View the connection status.
- **Disconnect Wi-Fi Direct:** Disconnect the connected device.

## › Kies via Wi-Fi

Connect your device to Samsung Kies via Wi-Fi.

## › Bluetooth settings

- **Bluetooth:** Turn the Bluetooth wireless feature on or off.  
▶ p. 105
- **Device name:** Set a Bluetooth name for your device.
- **Visible:** Set your device to be visible to other Bluetooth devices.
- **Visible time-out:** Set duration that your device is visible.
- **Scan for devices:** Search for available Bluetooth devices.

## › USB utilities

Connect your device to a PC as a mass storage. ▶ p. 116

## › Tethering and portable hotspot

- **USB tethering:** Activate the USB tethering feature to share your device's mobile network connection with PCs via USB. When connected to a PC, your device is used as a wireless modem for a PC. ▶ p. 114
- **Portable Wi-Fi hotspot settings:**
  - **Portable Wi-Fi hotspot:** Activate the Wi-Fi tethering feature to share your device's mobile network connection with PCs or other devices through the Wi-Fi feature.  
▶ p. 113
  - **Configure portable Wi-Fi hotspot:** Configure network settings to use your device as an access point.
- **Help:** Learn more about USB and Wi-Fi tethering.

## › VPN settings

Set up and connect to virtual private networks (VPNs).

▶ p. 117

## › Mobile networks

- **Use packet data:** Set to allow packet switched data networks for network services.
- **Data roaming:** Set the device to connect to another network when you are roaming or your home network is not available.
- **Access Point Names:** Set up access point names (APNs).
- **Network mode:** Select a network type.
- **Network operators:** Search for available networks and select a network for roaming.

## Call

Customise the settings for calling features.

- **Call rejection:** Set to reject calls from specified phone numbers automatically. You can add phone numbers to the reject list. ▶ p. 49
- **Set reject messages:** Add or edit the message that will be sent when you reject a call.
- **Call alert:**
  - **Answer vibration:** Set the device to vibrate when the other party answers a call.
  - **Call status tones:** Activate or deactivate call connection tone, minute minder tone, or call disconnection tone.
  - **Alerts on call:** Set the device to alert you to events during a call.



- **Call answering/ending:**
  - **Answering key:** Set the device to answer calls by pressing the Home key.
  - **Automatic answering:** Set to answer automatically after a specified period (available only when a headset is connected).
  - **The power key ends calls:** Set the device to end a call when you press the Power key.
- **Turn on proximity sensor:** Set to turn on the proximity sensor during a call.
- **Call forwarding:** Divert incoming calls to another number.
- **Additional settings:**
  - **Caller ID:** Display your caller ID to other parties for outgoing calls.
  - **Call barring:** Block incoming or outgoing calls.
  - **Call waiting:** Allow incoming call alerts when a call is in progress.
  - **Auto redial:** Activate auto redial for automatically redialling a call that was not connected or cut off during a call.
  - **Fixed Dialling Numbers:** Activate or deactivate FDN mode to restrict calls to numbers in the FDN list. You must enter the PIN2 supplied with your SIM or USIM card and reboot the device.
- **Video call image:** Select an image to be shown to the other party.
- **Own video in received call:** Set whether to show your live image or preset image to the other party.
- **Use call fail options:** Select whether or not to retry a voice call when a video call fails to connect.

- **Voicemail service:** Select your service provider or set another provider to receive voice mails.
- **Voicemail:** Enter the number to access the voice mail service. You can obtain this number from your service provider.

## Sound

Change the settings for various sounds on your device.

- **Silent mode:** Activate Silent mode to mute all sounds except media sounds and alarm ringtones.
- **Vibration:** Set when the device will vibrate for various events.
- **Volume:** Adjust the volume level for call ringtones, music and videos, device system sound, and notification ringtones.
- **Vibration intensity:** Adjust the vibration intensity.
- **Phone ringtone:** Select a ringtone to alert you to incoming calls.
- **Notification ringtone:** Select a ringtone to alert you to events, such as incoming messages, missed calls, and alarms.
- **Audible touch tones:** Set the device to sound when you touch the keys on the dialling screen.
- **Audible selection:** Set the device to sound when you select an application or option on the touch screen.
- **Screen lock sounds:** Set the device to sound when you lock or unlock the touch screen.
- **Haptic feedback:** Set the device to vibrate when you press the [≡] or [↵] or press and hold the Home key or the Power key.

## Display

Change the settings for the display.

- **Screen display:**
  - **Font style:** Change the font type for the display text. You can download fonts from Play Shop by selecting **Get fonts online**.
  - **Home screen:**
    - Wallpaper:** Select a background image for the idle screen.
  - **Lock screen:**
    - Wallpaper:** Select an image to display when the screen is locked.
    - Clock position:** Select the location of the clock on the locked screen. This feature is unavailable when you activate the screen lock feature.
- **Brightness:** Set the brightness of the display.
- **Auto-rotate screen:** Set whether or not to rotate the content automatically when the device is rotated.
- **Animation:** Set the device to display animation when you switch between windows.
- **Screen timeout:** Set the length of time the device waits before turning off the display's backlight.
- **Touch key light duration:** Set the duration for the touch key backlight.

## Power saving mode

- **Use Power saving mode:** Automatically activate Power saving mode when the battery is low.
- **Power saving on at:** Select a power level for Power saving mode.
- **Turn off Wi-Fi:** Deactivate the Wi-Fi feature when the device is not connected with a Wi-Fi AP.

- **Turn off Bluetooth:** Deactivate the Bluetooth feature when not in use.
- **Turn off GPS:** Deactivate the GPS feature when not in use.
- **Turn off Sync:** Turn off sync when the device is not synchronising with a web server.
- **Brightness:** Activate the brightness setting for Power saving mode.
- **Brightness:** Set the brightness level for Power saving mode.
- **Screen timeout:** Set the length of time the device waits before turning off the display's backlight.
- **Power saving tips:** Learn how to reduce battery consumption.

## Location and security

Change the settings for securing your device and the SIM or USIM card, and GPS functionality.

- **Use wireless networks:** Set to use Wi-Fi and/or mobile networks for finding your location.
- **Use GPS satellites:** Set to use the GPS satellite for finding your location.
- **Use sensor aiding:** Set to use sensors to enhance pedestrian positioning when the GPS signal is obstructed. There may be variations between the sensor estimates and your actual location.
- **Set up screen lock:** Set the unlock security code. When you have set your security code, this option changes to **Change screen lock**.
  - **None:** Disable the screen lock.
  - **Pattern:** Set an unlock pattern to unlock the screen.
  - **PIN:** Set a PIN (numeric) to unlock the screen.
  - **Password:** Set a password (alphanumeric) to unlock the screen.

- **Disable USB debugging mode:** Set the device to deactivate USB debugging mode when the screen is locked.
- **Set up SIM card lock:**
  - **Lock SIM card:** Activate or deactivate the PIN lock feature to require the PIN before using the device.
  - **Change SIM PIN:** Change the PIN used to access SIM or USIM data.
- **SIM change alert:** Activate or deactivate the Find my mobile feature which helps you locate your device when it is lost or stolen. ► p. 37
- **Alert message recipients:** Add or edit recipients for the alert message.
- **Remote controls:** Set to control a lost device remotely via the web.
- **Visible passwords:** Set the device to display your password as you enter.
- **Select device administrators:** View device administrators installed on your device. You can activate device administrators to apply new policies to your device.
- **Use secure credentials:** Use certificates and credentials to ensure secure use of various applications.
- **Install from USB storage:** Install encrypted certificates that are stored in the USB storage.
- **Set password:** Create and confirm a password for accessing credentials.
- **Clear storage:** Erase the credential contents from the device and reset the password.

## Applications

Change the settings for managing installed applications.

- **Unknown sources:** Select to download applications from any source. If you do not select this option, you can download applications only from Play Shop.

- **Manage applications:** Access the list of the applications installed on the device and check the application information.
- **Running services:** View the services you are using and access them to manage.
- **Storage usage:** View available memory and the memory used by applications on your device.
- **Battery usage:** View the amount of power consumed by your device.
- **Development:**
  - **USB debugging:** Select to connect your device to a PC by using a USB cable. This is for application development.
  - **Allow mock locations:** Allow mock locations and service information to be sent to a Location Manager service for testing. This is for application development.
- **Samsung Apps:** Select a network connection (Wi-Fi or packet switched data network) to get notifications for new applications from Samsung Apps.



This feature may be unavailable depending on your region or service provider.

## Accounts and sync

Change the settings for the auto sync feature or manage accounts for synchronisation.

- **Background data:** Select this setting to use the auto sync feature. The auto sync will run in the background without opening applications and synchronise data.
- **Auto-sync:** Set the device to synchronise contact, calendar, and email data automatically.

## Motion

Change the settings that control motion recognition on your device.

- **Motion activation:** Set to use motion recognition.
- **Turn over:** Set to mute incoming calls, alarms, music, and the FM radio by placing the device face down.
- **Tilt:** Set to zoom in or out while viewing images in Gallery or browsing web pages when you tap and hold two points with your fingers and then tilt the device back and forth.
- **Panning:** Set to move an item to another page when you tap and hold the item and then pan the device to the left or right.
- **Tutorial:** Learn how to control motions.

## Privacy

Change the settings for managing your settings and data.

- **Back up my data:** Set to back up your settings and application data to the Google server.
- **Automatic restore:** Set to restore your settings and application data when the applications are reinstalled on your device.
- **Factory data reset:** Reset your settings to the factory default values and delete all your data.

## Storage

View memory information for your device and memory card. You can also format the USB storage and a memory card.

-  Formatting a memory card will permanently delete all data from the memory card.

# Language and keyboard

Change the settings for text input.

## › Select language

Select a display language for all menus and applications.

## › Select input method

Select a default keyboard type for text input.

## › Swype

- **Select Input Method:** Change the keyboard type.
- **How to Swype:** Learn how to enter text with the Swype keyboard.
- **Personal dictionary:** Set up your own dictionary. The words in your dictionary will appear as suggestions for your text inputs.
- **Preferences:**
  - **Audio feedback:** Set to alert you when there are no alternative words for your input if you double-tap a word.
  - **Vibrate on keypress:** Set the device to vibrate when you touch a key.
  - **Show tips:** Set the device to automatically display tips for your actions when available.
  - **Auto-spacing:** Set the device to automatically insert a space between words.
  - **Auto-capitalization:** Set the device to automatically capitalise the first letter after a final punctuation mark, such as a full stop, question mark, or exclamation mark.
  - **Show complete trace:** Set to display the trace of your dragging on the keyboard.



- **Word suggestion:** Set the device to predict words according to your input and display word suggestions.
- **Speed vs. accuracy:** Set the ratio between the speed and accuracy of Swype suggestions.
- **Reset Swype's dictionary:** Delete the words you have added to the dictionary.
- **Version:** View version information.
- **Language Options:** Select languages for text input.

## › Samsung keypad

- **Portrait keypad types:** Select the default input method, such as the QWERTY keyboard, traditional keypad, or handwriting screen.
- **Input languages:** Select languages for text input.



You cannot enter text in some languages. To enter text, you should change the writing language to one of the supported languages.

- **XT9:** Activate XT9 mode to enter text using Predictive input mode.
- **XT9 advanced settings:** Activate the advanced features of XT9 mode, such as auto completion, auto correction, or auto substitution, and set up your own word list.
- **Keypad sweeping:** Enable or disable the keypad sweeping feature for the text input mode. You can switch between input modes by scrolling left or right on the keypad.
- **Character preview:** Set the device to display a large image of each letter you touch.
- **Auto-capitalization:** Set the device to automatically capitalise the first letter after a final punctuation mark, such as a full stop, question mark, or exclamation mark.
- **Handwriting settings:** Customise the recognition time in Handwriting mode.

- **Voice input:** Activate the voice input feature to enter text by voice on the Samsung keypad.
- **Auto-full stop:** Set the device to insert a full stop when you double-tap the space bar.
- **Tutorial:** Learn how to enter text with the Samsung keypad.

## Voice input and output

Change the settings for the voice recogniser and the text-to-speech feature.

### › Voice recognition

Select a voice recognition engine.

### › Voice recognition settings

For the Samsung voice recognition, use the following options:

- **Language:** Select a language for the voice recognition.
- **Web search engine:** Select a web search engine.
- **Auto-dial:** Set to automatically dial a number when the voice recognition result is confident.
- **Use location:** Set to use your location information for voice search results.
- **Hide offensive words:** Hide offensive words your device recognised from voice search results.
- **Auto-punctuation:** Set to automatically insert punctuation marks when needed.
- **Listen over Bluetooth:** Set to recognise your voice commands when using a connected Bluetooth headset.
- **Voice talk unique ID:** View your device's unique ID for services when you have problems with Voice talk.
- **About:** View version information.

- **Auto-start listening:** Set to automatically begin voice recognition when you launch the voice command feature.
- **Voice command help:** Access help information for using the voice command feature.
- **Social settings:** Change the settings for accessing community websites.
- **Voice talk settings:** Change the settings for using Voice talk.
- **Voice talk help:** Access help information for using Voice talk.

For the Google voice recognition, use the following options:

- **Language:** Select a language for the voice recognition.
- **SafeSearch:** Set the device to filter explicit text and/or images from voice search results.
- **Block offensive words:** Hide offensive words your device recognised from voice search results.

## › Text-to-speech settings

- **Listen to an example:** Listen to the spoken text for an example.
- **Driving mode:** Activate Driving mode to set the device to read contents aloud.
- **Driving mode settings:** Specify applications to use in Driving mode.
- **Always use my settings:** Set to use the speech rate and language settings you specify over the settings saved in applications.
- **Default engine:** Set the speech synthesis engine to be used for spoken text.
- **Install voice data:** Download and install voice data for the text-to-speech feature.

- **Speech rate:** Select a speed for the text-to-speech feature.
- **Language:** Select a language for the text-to-speech feature.
- **Engines:** View the text-to-speech engines in your device.

## Accessibility

Accessibility services are special features for those with certain physical disabilities. Access and alter the following settings to improve the device accessibility.

- **Accessibility:** Activate an accessibility application you have downloaded, such as Talkback or Kickback, which provide voice, melody, or vibration feedback.
- **Accessibility services:** Select an accessibility application to use.
- **Assistive light:** Turn the assistive light on or off.
- **Mono audio:** Enable mono sound when you listen to audio with one earbud.
- **Call answering/ending:**
  - **Answering key:** Set the device to answer an incoming call when you press the Home key.
  - **Automatic answering:** Set the length of time the device waits before answer an incoming call.
  - **The power key ends calls:** Set the device to end a call when you press the Power key.
- **Accessibility shortcut:** Add a shortcut to Accessibility settings on the quick menu that appears when you press and hold the Power key.

## Date and time

Access and alter the following settings to control how time and date are displayed on your device:



If the battery remains fully discharged or removed from the device, the time and date will be reset.

- **Automatic:** Automatically update the time when you move across time zones.
- **Set date:** Set the current date manually.
- **Select time zone:** Set your home time zone.
- **Set time:** Set the current time manually.
- **Use 24-hour format:** Set to the time to be displayed in 24-hour format.
- **Select date format:** Select a date format.

## About phone

Access information about your device, check the device's status, and update the device system.

# Troubleshooting

When you turn on your device or while you are using the device, it prompts you to enter one of the following codes:

| Code     | Try this to solve the problem:   |
|----------|--|
| Password | When the device lock feature is enabled, you must enter the password you set for the device.   |
| PIN      | When using the device for the first time or when the PIN requirement is enabled, you must enter the PIN supplied with the SIM or USIM card. You can disable this feature by using the <b>Lock SIM card</b> menu. |
| PUK      | Your SIM or USIM card is blocked, usually as a result of entering your PIN incorrectly several times. You must enter the PUK supplied by your service provider.  |
| PIN2     | When you access a menu requiring the PIN2, you must enter the PIN2 supplied with the SIM or USIM card. For details, contact your service provider.   |

## Your device displays network or service error messages

- When you are in areas with weak signals or poor reception, you may lose reception. Move to another area and try again.
- You cannot access some options without a subscription. Contact your service provider for more details.

## The touch screen responds slowly or improperly

If your device has a touch screen and the touch screen is not responding properly, try the following:

- Remove any protective covers from the touch screen. Protective covers may prevent the device from recognising your inputs and are not recommended for touch screen devices.
- Ensure that your hands are clean and dry when tapping the touch screen.
- Restart your device to clear any temporary software bugs.
- Ensure that your device software is upgraded to the latest version.
- If the touch screen is scratched or damaged, take it to your local Samsung Service Centre.

## Your device freezes or has fatal errors

If your device freezes or hangs, you may need to close programs or reset the device to regain functionality. If your device is frozen and unresponsive, press and hold the Power key for 8-10 seconds. The device will reboot automatically.

If this does not solve the problem, perform a factory data reset. In Idle mode, open the application list and select **Settings** → **Privacy** → **Factory data reset** → **Reset phone** → **Erase everything**.

## Calls are being dropped

When you are in areas with weak signals or poor reception, you may lose your connection to the network. Move to another area and try again.

## Outgoing calls are not connected

- Ensure that you have pressed the Dial key.
- Ensure that you have accessed the right cellular network.
- Ensure that you have not set call barring for the phone number you are dialling.

## Incoming calls are not connected

- Ensure that your device is turned on.
- Ensure that you have accessed the right cellular network.
- Ensure that you have not set call barring for the incoming phone number.

## Others cannot hear you speaking on a call

- Ensure that you are not covering the built-in microphone.
- Ensure that the microphone is close to your mouth.
- If using a headset, ensure that it is properly connected.

## Audio quality is poor

- Ensure that you are not blocking the device's internal antenna.
- When you are in areas with weak signals or poor reception, you may lose reception. Move to another area and try again.

## When dialling from contacts, the call is not connected

- Ensure that the correct number is stored in the contact list.
- Re-enter and save the number, if necessary.
- Ensure that you have not set call barring for the contact's phone number.

## The device beeps and the battery icon is empty

Your battery is low. Recharge or replace the battery to continue using the device.



## The battery does not charge properly or the device turns off

- The battery terminals may be dirty. Wipe both gold-coloured contacts with a clean, soft cloth and try charging the battery again.
- If the battery will no longer charge completely, dispose of the old battery properly and replace it with a new battery (refer to your local ordinances for proper disposal instructions).

## Your device is hot to the touch

When you use applications that require more power or use applications on your device for an extended period of time, your device may feel hot to the touch. This is normal and should not affect your device's lifespan or performance.

## Error messages appear when launching the camera

Your Samsung mobile device must have sufficient available memory and battery power to operate the camera application. If you receive error messages when launching the camera, try the following:

- Charge the battery or replace it with a battery that is fully charged.
- Free some memory by transferring files to a PC or deleting files from your device.
- Restart the device. If you are still having trouble with the camera application after trying these tips, contact a Samsung Service Centre.

## **Error messages appear when launching the FM radio**

The FM radio application on your Samsung mobile device uses the headset cable as an antenna. Without a headset connected, the FM radio will be unable to receive radio stations. To use the FM radio, first ensure that the headset is properly connected. Next, scan for and save the available radio stations.

If you still cannot use the FM radio after performing these steps, try accessing your desired station with another radio receiver. If you can hear the station with another receiver, your device may require service. Contact a Samsung Service Centre.

## **Error messages appear when opening music files**

Some music files may not play on your Samsung mobile device for a variety of reasons. If you receive error messages when opening music files on your device, try the following:

- Free some memory by transferring files to a PC or deleting files from your device.
- Ensure that the music file is not Digital Rights Management (DRM)-protected. If the file is DRM-protected, ensure that you have the appropriate licence or key to play the file.
- Ensure that your device supports the file type.

## Another Bluetooth device is not located

- Ensure that the Bluetooth wireless feature is activated on your device.
- Ensure that the Bluetooth wireless feature is activated on the device you wish to connect to, if necessary.
- Ensure that your device and the other Bluetooth device are within the maximum Bluetooth range (10 m).

If the tips above do not solve the problem, contact a Samsung Service Centre.

## A connection is not established when you connect the device to a PC

- Ensure that the USB cable you are using is compatible with your device.
- Ensure that you have the proper drivers installed and updated on your PC.

# Safety precautions

To prevent injury to yourself and others or damage to your device, read all of the following information before using your device.

## Warning: Prevent electric shock, fire, and explosion

**Do not use damaged power cords or plugs, or loose electrical sockets**

**Do not touch the power cord with wet hands, or disconnect the charger by pulling on the cord**

**Do not bend or damage the power cord**

**Do not use your device while charging or touch your device with wet hands**

**Do not short-circuit the charger or the battery**

**Do not drop or cause an impact to the charger or the battery**

**Do not charge the battery with chargers that are not approved by the manufacturer**

**Do not use your device during a thunderstorm**

Your device may malfunction and your risk of electric shock is increased.

**Do not handle a damaged or leaking Lithium Ion (Li-Ion) battery**

For safe disposal of your Li-Ion batteries, contact your nearest authorised service centre.

**Handle and dispose of batteries and chargers with care**

- Use only Samsung-approved batteries and chargers specifically designed for your device. Incompatible batteries and chargers can cause serious injuries or damage to your device.
- Never dispose of batteries or devices in a fire. Follow all local regulations when disposing of used batteries or devices.

- Never place batteries or devices on or in heating devices, such as microwave ovens, stoves, or radiators. Batteries may explode when overheated.
- Never crush or puncture the battery. Avoid exposing the battery to high external pressure, which can lead to an internal short circuit and overheating.

### **Protect the device, batteries, and chargers from damage**

- Avoid exposing your device and batteries to very cold or very hot temperatures.
- Extreme temperatures can cause the deformation of the device and reduce the charging capacity and life of your device and batteries.
- Prevent batteries from contacting metal objects, as this can create a connection between the + and – terminals of your batteries and lead to temporary or permanent battery damage.
- Never use a damaged charger or battery.

## **Caution: Follow all safety warnings and regulations when using your device in restricted areas**

### **Turn off your device where prohibited**

Comply with all regulations that restrict the use of a mobile device in a particular area.

### **Do not use your device near other electronic devices**

Most electronic devices use radio frequency signals. Your device may interfere with other electronic devices.

### **Do not use your device near a pacemaker**

- Avoid using your device within a 15 cm range of a pacemaker if possible, as your device can interfere with the pacemaker.
- If you must use your device, keep it at least 15 cm away from the pacemaker.
- To minimise the possible interference with a pacemaker, use your device on the opposite side of your body from the pacemaker.

### **Do not use your device in a hospital or near medical equipment that can be interfered with by radio frequency**

If you personally use any medical equipment, contact the manufacturer of the equipment to ensure the safety of your equipment from radio frequency.

## **If you are using a hearing aid, contact the manufacturer for information about radio interference**

Some hearing aids may be interfered with by the radio frequency of your device. Contact the manufacturer to ensure the safety of your hearing aid.

## **Turn off the device in potentially explosive environments**

- Turn off your device in potentially explosive environments instead of removing the battery.
- Always comply with regulations, instructions and signs in potentially explosive environments.
- Do not use your device at refuelling points (service stations), near fuels or chemicals, and at blasting areas.
- Do not store or carry flammable liquids, gases, or explosive materials in the same compartment as the device, its parts, or accessories.

## **Turn off your device when in an aircraft**

Using your device in an aircraft is illegal. Your device may interfere with the electronic navigation instruments of the aircraft.

## **Electronic devices in a motor vehicle may malfunction due to the radio frequency of your device**

Electronic devices in your car may malfunction due to radio frequency of your device. Contact the manufacturer for more information.

# **Comply with all safety warnings and regulations regarding mobile device usage while operating a vehicle**

While driving, safely operating the vehicle is your first responsibility. Never use your mobile device while driving, if it is prohibited by law. For your safety and the safety of others, practice good common sense and remember the following tips:

- Get to know your device and its convenience features, such as speed dial and redial. These features help you reduce the time needed to place or receive calls on your mobile device.
- Position your device within easy reach. Be able to access your wireless device without removing your eyes from the road. If you receive an incoming call at an inconvenient time, let your voice mail answer it for you.

- Suspend calls in heavy traffic or hazardous weather conditions. Rain, sleet, snow, ice, and heavy traffic can be hazardous.
- Do not take notes or look up phone numbers. Jotting down a “to do” list or flipping through your address book takes attention away from your primary responsibility of driving safely.
- Dial sensibly and assess the traffic. Place calls when you are not moving or before pulling into traffic. Try to plan calls when your car will be stationary.
- Do not engage in stressful or emotional conversations that may be distracting. Make people you are talking with aware you are driving and suspend conversations that have the potential to divert your attention from the road.
- Use your device to call for help. Dial a local emergency number in the case of fire, traffic accident, or medical emergencies.
- Use your device to help others in emergencies. If you see an auto accident, a crime in progress, or a serious emergency where lives are in danger, call a local emergency number.
- Call roadside assistance or a special, non-emergency assistance number when necessary. If you see a broken-down vehicle posing no serious hazard, a broken traffic signal, a minor traffic accident where no one appears injured, or a vehicle you know to be stolen, call roadside assistance or another special, non-emergency number.

## Proper care and use of your mobile device

### Keep your device dry

- Humidity and all types of liquids may damage device parts or electronic circuits.
- Do not turn on your device if it is wet. If your device is already on, turn it off and remove the battery immediately (if the device will not turn off or you cannot remove the battery, leave it as-is). Then, dry the device with a towel and take it to a service centre.
- Liquids will change the colour of the label that indicates water damage inside the device. Water damage to your device can void your manufacturer’s warranty.

## **Do not use or store your device in dusty, dirty areas**

Dust can cause your device to malfunction.

## **Do not store your device on slopes**

If your device falls, it can be damaged.

## **Do not store your device in hot or cold areas. Use your device at -20 °C to 50 °C**

- Your device can explode if left inside a closed vehicle, as the inside temperature can reach up to 80 °C.
- Do not expose your device to direct sunlight for extended periods of time (such as on the dashboard of a car).
- Store the battery at 0 °C to 40 °C.

## **Do not store your device with such metal objects as coins, keys and necklaces**

- Your device may become deformed or malfunction.
- If the battery terminals are in contact with metal objects, it may cause a fire.

## **Do not store your device near magnetic fields**

- Your device may malfunction or the battery may discharge from exposure to magnetic fields.
- Magnetic stripe cards, including credit cards, phone cards, passbooks, and boarding passes, may be damaged by magnetic fields.
- Do not use carrying cases or accessories with magnetic closures or allow your device to come in contact with magnetic fields for extended periods of time.

## **Do not store your device near or in heaters, microwaves, hot cooking equipment, or high pressure containers**

- The battery may leak.
- Your device may overheat and cause a fire.

## **Do not drop your device or cause impacts to your device**

- The screen of your device may be damaged.
- If bent or deformed, your device may be damaged or parts may malfunction.

## **Do not use your device or applications for a while if the device is overheated**

Prolonged exposure of your skin to an overheated device may cause low temperature burn symptoms, such as red spots and pigmentation.



## **If your device has a camera flash or light, do not use a flash close to the eyes of people or pets**

Using a flash close to the eyes may cause temporary loss of vision or damage to the eyes.

## **Use caution when exposed to flashing lights**

- While using your device, leave some lights on in the room and do not hold the screen too close to your eyes.
- Seizures or blackouts can occur when you are exposed to flashing lights while watching videos or playing Flash-based games for extended periods. If you feel any discomfort, stop using the device immediately.

## **Reduce the risk of repetitive motion injuries**

When you repetitively perform actions, such as pressing keys, drawing characters on a touch screen with your fingers, or playing games, you may experience occasional discomfort in your hands, neck, shoulders, or other parts of your body. When using your device for extended periods, hold the device with a relaxed grip, press the keys lightly, and take frequent breaks. If you continue to have discomfort during or after such use, stop use and see a physician.

## **Ensure maximum battery and charger life**

- Avoid charging batteries for more than a week, as overcharging may shorten battery life.
- Over time, unused batteries will discharge and must be recharged before use.
- Disconnect chargers from power sources when not in use.
- Use batteries only for their intended purposes.

## **Use manufacturer-approved batteries, chargers, accessories and supplies**

- Using generic batteries or chargers may shorten the life of your device or cause the device to malfunction.
- Samsung cannot be responsible for the user's safety when using accessories or supplies that are not approved by Samsung.

## **Do not bite or suck on the device or the battery**

- Doing so may damage the device or cause explosion.
- If children use the device, make sure that they use the device properly.

## **Do not insert the device or supplied accessories into the eyes, ears, or mouth**

Doing so may cause suffocation or serious injuries.

### **When speaking on the device:**

- Hold the device upright, as you would with a traditional phone.
- Speak directly into the mouthpiece.
- Do not touch the device's internal antenna. Doing so may result in reduced call quality or cause the device to emit unintended levels of radio frequency (RF) energy.

### **Protect your hearing and ears when using a headset**



- Excessive exposure to loud sounds can cause hearing damage.
- Exposure to loud sounds while driving may distract your attention and cause an accident.
- Always turn the volume down before plugging the earphones into an audio source and use only the minimum volume setting necessary to hear your conversation or music.
- In dry environments, static electricity can build up in the headset. Avoid using headsets in dry environments or touch a metal object to discharge static electricity before connecting a headset to the device.

### **Use caution when using the device while walking or moving**

- Always be aware of your surroundings to avoid injury to yourself or others.
- Make sure the headset cable does not become entangled in your arms or on nearby objects.

### **Do not carry your device in your back pockets or around your waist**

You can be injured or damage the device if you fall.

### **Do not disassemble, modify, or repair your device**

- Any changes or modifications to your device can void your manufacturer's warranty. For service, take your device to a Samsung Service Centre.
- Do not disassemble or puncture the battery, as this can cause explosion or fire.

## **Do not paint or put stickers on your device**

Paint and stickers can clog moving parts and prevent proper operation. If you are allergic to paint or metal parts of the product, you may experience itching, eczema, or swelling of the skin. When this happens, stop using the product and consult your physician.

## **When cleaning your device:**

- Wipe your device or charger with a towel or an eraser.
- Clean the terminals of the battery with a cotton ball or a towel.
- Do not use chemicals or detergents.

## **Do not use the device if the screen is cracked or broken**

Broken glass or acrylic could cause injury to your hands and face. Take the device to a Samsung Service Centre to have it repaired.

## **Do not use the device for anything other than its intended use**

## **Avoid disturbing others when using the device in public**

## **Do not allow children to use your device**

Your device is not a toy. Do not allow children to play with it as they could hurt themselves and others, damage the device, or make calls that increase your charges.

## **Install mobile devices and equipment with caution**

- Ensure that any mobile devices or related equipment installed in your vehicle are securely mounted.
- Avoid placing your device and accessories near or in an air bag deployment area. Improperly installed wireless equipment can cause serious injury when air bags inflate rapidly.

## **Allow only qualified personnel to service your device**

Allowing unqualified personnel to service your device may result in damage to your device and will void your manufacturer's warranty.

## **Handle SIM cards or memory cards with care**

- Do not remove a card while the device is transferring or accessing information, as this could result in loss of data and/or damage to the card or device.
- Protect cards from strong shocks, static electricity, and electrical noise from other devices.
- Do not touch gold-coloured contacts or terminals with your fingers or metal objects. If dirty, wipe the card with a soft cloth.

## Ensure access to emergency services

Emergency calls from your device may not be possible in some areas or circumstances. Before travelling in remote or undeveloped areas, plan an alternative method of contacting emergency services personnel.

## Keep your personal and important data safe

- While using your device, be sure to back up important data. Samsung is not responsible for data loss.
- When disposing of your device, back up all data and then reset your device to prevent misuse of your personal information.
- Carefully read the permissions screen when downloading applications. Be particularly cautious with applications that have access to many functions or to a significant amount of your personal information.
- Check your accounts regularly for unauthorised or suspicious use. If you find any sign of misuse of your personal information, contact your service provider to delete or change your account information.
- In the event your device is lost or stolen, change the passwords on your accounts to protect your personal information.
- Avoid using applications from unknown sources and lock your device with a pattern, password, or PIN.

## Do not distribute copyright-protected material

Do not distribute copyright-protected material that you have recorded to others without the permission of the content owners. Doing this may violate copyright laws. The manufacturer is not liable for any legal issues caused by the user's illegal use of copyrighted material.

### RiskGroup 2



**CAUTION. Possibly hazardous optical radiation emitted from this product. Do not stare at operating lamp. May be harmful to the eye.**

***Product tested against IEC62471***

## Correct disposal of this product

(Waste Electrical & Electronic Equipment)



(Applicable in the European Union and other European countries with separate collection systems)

This marking on the product, accessories or literature indicates that the product and its electronic accessories (e.g. charger, headset, USB cable) should not be disposed of with other household waste at the end of their working life.

To prevent possible harm to the environment or human health from uncontrolled waste disposal, please separate these items from other types of waste and recycle them responsibly to promote the sustainable reuse of material resources.

Household users should contact either the retailer where they purchased this product, or their local government office, for details of where and how they can take these items for environmentally safe recycling.

Business users should contact their supplier and check the terms and conditions of the purchase contract. This product and its electronic accessories should not be mixed with other commercial wastes for disposal.

This EEE is compliant with RoHS.

## Correct disposal of batteries in this product



(Applicable in the European Union and other European countries with separate battery return systems)

This marking on the battery, manual or packaging indicates that the batteries in this product should not be disposed of with other household waste at the end of their working life. Where marked, the chemical symbols Hg, Cd or Pb indicate that the

battery contains mercury, cadmium or lead above the reference levels in EC Directive 2006/66. If batteries are not properly disposed of, these substances can cause harm to human health or the environment.

To protect natural resources and to promote material reuse, please separate batteries from other types of waste and recycle them through your local, free battery return system.

## Disclaimer

Some content and services accessible through this device belong to third parties and are protected by copyright, patent, trademark and/or other intellectual property laws. Such content and services are provided solely for your personal noncommercial use. You may not use any content or services in a manner that has not been authorised by the content owner or service provider. Without limiting the foregoing, unless expressly authorised by the applicable content owner or service provider, you may not modify, copy, republish, upload, post, transmit, translate, sell, create derivative works, exploit, or distribute in any manner or medium any content or services displayed through this device.

“THIRD PARTY CONTENT AND SERVICES ARE PROVIDED “AS IS.” SAMSUNG DOES NOT WARRANT CONTENT OR SERVICES SO PROVIDED, EITHER EXPRESSLY OR IMPLIEDLY, FOR ANY PURPOSE. SAMSUNG EXPRESSLY DISCLAIMS ANY IMPLIED WARRANTIES, INCLUDING BUT NOT LIMITED TO, WARRANTIES OF MERCHANTABILITY OR FITNESS FOR A PARTICULAR PURPOSE. SAMSUNG DOES NOT GUARANTEE THE ACCURACY, VALIDITY, TIMELINESS, LEGALITY, OR COMPLETENESS OF ANY CONTENT OR SERVICE MADE AVAILABLE THROUGH THIS DEVICE AND UNDER NO CIRCUMSTANCES, INCLUDING NEGLIGENCE, SHALL SAMSUNG BE LIABLE, WHETHER IN CONTRACT OR TORT, FOR ANY DIRECT, INDIRECT, INCIDENTAL, SPECIAL OR CONSEQUENTIAL DAMAGES, ATTORNEY FEES, EXPENSES, OR ANY OTHER DAMAGES ARISING OUT OF, OR IN CONNECTION WITH, ANY INFORMATION CONTAINED IN, OR AS A RESULT OF THE USE OF ANY CONTENT OR SERVICE BY YOU OR ANY THIRD PARTY, EVEN IF ADVISED OF THE POSSIBILITY OF SUCH DAMAGES.”

Third party services may be terminated or interrupted at any time, and Samsung makes no representation or warranty that any content or service will remain available for any period of time. Content and services are transmitted by third parties by means of networks and transmission facilities over which Samsung has no control. Without limiting the generality of this disclaimer, Samsung expressly disclaims any responsibility or liability for any interruption or suspension of any content or service made available through this device. Samsung is neither responsible nor liable for customer service related to the content and services. Any question or request for service relating to the content or services should be made directly to the respective content and service providers.

# Index

- access codes 150
- alarms
  - creating 120
  - deactivating 120
  - stopping 120
- AllShare 111
- auto rejection 49
- battery
  - charging 13
  - installing 11
- Bluetooth
  - activating 105
  - finding and pairing with devices 106
  - receiving data 107
  - sending data 106
- brightness, display 34
- calculator 122
- calendar
  - creating events 88
  - viewing events 89
- call barring 51
- call forwarding 50
- call log 51
- calls
  - answering 46
  - barring 51
  - forwarding 50
  - international numbers 46
  - multiparty 47
  - rejecting 46
  - using headset 46
  - using options during voice 47
  - viewing missed 48
  - waiting 51
- call waiting 51
- camera
  - capturing photos 62
  - customising camcorder 71
  - customising camera 67
  - recording videos 69
- connections
  - Bluetooth 105
  - DLNA 110
  - PC 115
  - VPN 117
  - Wi-Fi 107
- contacts
  - copying 87
  - creating 84
  - finding 85
  - importing or exporting 87
  - setting speed dial 85
- device
  - customising 33
  - indicator icons 23
  - keys 22
  - layout 20
  - notifications panel 29
  - settings 134
  - turning on or off 19
- display language 144

- DLNA
  - see AllShare
- downloads
  - applications 41
  - files 42
  - managing 123
- email
  - sending 57
  - setting accounts 56
  - viewing 57
- file manager 125
- find my mobile 37
- fixed dialling number mode 50
- flight mode 19
- FM radio
  - listening to 81
  - saving stations 82
- gallery
  - file formats 73
  - playing videos 75
  - viewing photos 74
- Google Latitude 98
- Google Mail 54
- Google Maps 97
- Google Search 131
- Google Talk 58
- idle screen
  - adding items 28
  - adding panels 29
- internet
  - see web browser
- map
  - getting directions 98
  - searching for locations 97
  - searching for nearby places 99
  - sharing locations with friends 98
  - using navigation 100
- memory card
  - formatting 18
  - inserting 16
  - removing 17
- memos
  - creating 90
  - viewing 91
- menu screen
  - accessing 30
  - adding folders or panels 31
  - organising applications 31
- messages
  - accessing voice mail 54
  - sending email 57
  - sending multimedia 52
  - sending text 52
  - setting email accounts 56
- mini diary 124
- multimedia messages
  - sending 52
  - viewing 53
- music hub 80
- music player
  - adding files 77
  - creating playlists 79
  - playing music 78
- navigation 100



- news & weather 103
- PC connections
  - mass storage 116
  - Samsung Kies 116
- phonebook
  - creating contacts 84
  - creating groups 86
  - creating your namecard 85
  - finding contacts 85
- photo editor 76
- photos
  - capturing 62
  - capturing action 66
  - capturing by scene 64
  - capturing in cartoon mode 66
  - capturing in smile shot 65
  - capturing panoramic 65
  - capturing yourself 64
  - viewing 74
- PIN lock 36
- Polaris Office 125
- projector 127
- Samsung Apps 102
- Samsung Kies 116
- settings
  - about phone 149
  - accessibility 148
  - accounts and sync 142
  - applications 141
  - call 136
  - date and time 149
  - display 139
  - language and keyboard 144
  - location and security 140
  - motion 143
  - power saving mode 139
  - privacy 143
  - sound 138
  - storage 143
  - voice input and output 146
  - wireless and network 134
- silent mode 33
- SIM card
  - installing 11
  - locking 36
- Social Hub 61
- stopwatch 121
- synchronisation
  - with web accounts 43
- task manager 132
- tasks
  - creating 90
  - viewing 90
- text input 37
- text memos 90
- text messages
  - sending 52
  - viewing 53
- time and date, set 33
- torch light 130
- touch screen
  - locking 27
  - using 26
- unpack 10

- USIM card
  - installing 11
  - locking 36
- video calls
  - answering 46
  - making 45
  - using options 48
- video player 73, 75
- videos
  - playing 72, 75
  - recording 69
- voice calls
  - answering 46
  - making 45
  - using options 47
- voice command 132
- voice mail 54
- voice memos
  - playing 92
  - recording 92
- voice search 133
- VPN connections
  - connecting to 119
  - creating 118
- web browser
  - adding bookmarks 95
  - browsing web pages 93
- Wi-Fi
  - activating 108
  - finding and connecting to networks 108
  - using WPS 109
- world clock 121
- YouTube
  - uploading videos 101
  - watching videos 101

## Declaration of Conformity (R&TTE)

We, **Samsung Electronics**

declare under our sole responsibility that the product

**GSM WCDMA BT/Wi-Fi Mobile Phone : GT-I8530**

to which this declaration relates, is in conformity with the following standards and/or other normative documents.

|               |                                       |
|---------------|---------------------------------------|
| <b>SAFETY</b> | <b>EN 60950-1 : 2006 + A1 : 2010</b>  |
|               | <b>EN 50360 : 2001 / AC 2006</b>      |
|               | <b>EN 62209 - 1 : 2006</b>            |
| <b>SAR</b>    | <b>EN 62209 - 2 : 2010</b>            |
|               | <b>EN 62479 : 2010</b>                |
|               | <b>EN 62311 : 2008</b>                |
|               | <b>EN 301 489-01 V1.8.1 (04-2008)</b> |
|               | <b>EN 301 489-07 V1.3.1 (11-2005)</b> |
| <b>EMC</b>    | <b>EN 301 489-17 V2.1.1 (05-2009)</b> |
|               | <b>EN 301 489-24 V1.5.1 (10-2010)</b> |
|               | <b>EN 301 511 V9.0.2 (03-2003)</b>    |
| <b>RADIO</b>  | <b>EN 301 908-1 V4.2.1 (03-2010)</b>  |
|               | <b>EN 301 908-2 V4.2.1 (03-2010)</b>  |
|               | <b>EN 300 328 V1.7.1 (10-2006)</b>    |

We hereby declare that [all essential radio test suites have been carried out and that] the above named product is in conformity to all the essential requirements of Directive 1999/5/EC.

The conformity assessment procedure referred to in Article 10 and detailed in Annex[IV] of Directive 1999/5/EC has been followed with the involvement of the following Notified Body(ies):

**BABT, Forsyth House, Churchfield Road, Walton-on-Thames,  
Surrey, KT12 2TD, UK ✱  
Identification mark: 0168**



The technical documentation kept at :

Samsung Electronics QA Lab.

which will be made available upon request.  
(Representative in the EU)

Samsung Electronics Euro QA Lab.  
Blackbushe Business Park, Saxony Way,  
Yateley, Hampshire, GU46 6GG, UK ✱



**Joong-Hoon Choi / Lab Manager**

2012.04.24

(place and date of issue)

(name and signature of authorised person)

✱ It is not the address of Samsung Service Centre. For the address or the phone number of Samsung Service Centre, see the warranty card or contact the retailer where you purchased your product.

Some of the contents in this manual may differ from your device depending on the software of the device or your service provider.

### To install Kies (PC Sync) Kies

1. Download the latest version of Kies from the Samsung website ([www.samsung.com/kies](http://www.samsung.com/kies)) and install it on your PC.
2. Using a USB cable, connect your device to your PC.
3. Double-click the Samsung Kies icon on your PC to launch Samsung Kies.  
Refer to the Kies help for more information.